

KENWOOD

AUDIO VIDEO SURROUND RECEIVER

VR-707
KRF-V6070D

INSTRUCTION MANUAL

KENWOOD CORPORATION

This instruction manual is for some models. Model availability and features (functions) may differ depending on the country and sales area.

About the supplied remote control

Compared to standard remote controls, the remote control supplied with this receiver has several operation modes. These modes enable the remote control to control other audio/video components. In order to effectively use the remote control it is important to read the operating instructions and obtain a proper understanding of the remote control and how to switch its operation modes (etc.). Using the remote control without completely understanding its design and how to switch the operation modes may result in incorrect operations.

Before applying the power

⚠ Caution : Read this page carefully to ensure safe operation.

Units are designed for operation as follows.

- U.S.A. and Canada AC 120 V only
- Australia AC 240 V only
- Europe and U.K. AC 230 V only
- China and Russia AC 220 V only
- Other countries AC 110-120 / 220-240 V switchable*

* AC voltage selection

The AC voltage selector switch on the rear panel is set to the voltage that prevails in the area to which the unit is shipped. Before connecting the power cord to your AC outlet, make sure that the setting position of this switch matches your line voltage. If not, it must be set to your voltage in accordance with the following direction.

AC voltage selector switch

Move switch lever to match your line voltage with a small screwdriver or other pointed tool.

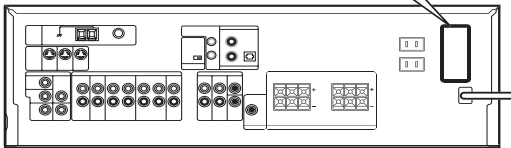
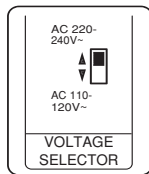

Note :
Our warranty does not cover damage caused by excessive line voltage due to improper setting of the AC voltage selector switch.

How to use this manual

This manual is divided into four sections, Preparations, Operations, Remote Control, and Additional Information.

Preparations

Shows you how to connect your audio and video components to the receiver and prepare the surround processor. Since this receiver works with all of your audio and video components, we will guide you in setting up your system to be as easy as possible.

Operations

Shows you how to operate the various functions available on the receiver.

Remote Control

Shows you how to operate other components using the remote control, as well as a detailed explanation of all remote control operations. Once you have registered your components with the proper setup codes, you'll be able to operate both this receiver and your other AV components (TV, VCR, DVD player, CD player, etc.) using the remote control supplied with this receiver.

Additional Information

Shows you additional information such as "In case of difficulty" (troubleshooting) and "Specifications".

Safety precautions

WARNING :

TO PREVENT FIRE OR ELECTRIC SHOCK, DO NOT EXPOSE THIS APPLIANCE TO RAIN OR MOISTURE.



CAUTION
RISK OF ELECTRIC SHOCK
DO NOT OPEN



CAUTION: TO REDUCE THE RISK OF ELECTRIC SHOCK, DO NOT REMOVE COVER (OR BACK). NO USER-SERVICEABLE PARTS INSIDE. REFER SERVICING TO QUALIFIED SERVICE PERSONNEL.







THE LIGHTNING FLASH WITH ARROWHEAD SYMBOL, WITHIN AN EQUILATERAL TRIANGLE, IS INTENDED TO ALERT THE USER TO THE PRESENCE OF UNINSULATED "DANGEROUS VOLTAGE" WITHIN THE PRODUCT'S ENCLOSURE THAT MAY BE OF SUFFICIENT MAGNITUDE TO CONSTITUTE A RISK OF ELECTRIC SHOCK TO PERSONS.



THE EXCLAMATION POINT WITHIN AN EQUILATERAL TRIANGLE IS INTENDED TO ALERT THE USER TO THE PRESENCE OF IMPORTANT OPERATING AND MAINTENANCE (SERVICING) INSTRUCTIONS IN THE LITERATURE ACCOMPANYING THE APPLIANCE.

Contents

Caution : Read the pages marked  carefully to ensure safe operation.

Preparations	 Before applying the power 2
	 Safety precautions 2
	How to use this manual 2
	Unpacking 3
	Preparing the remote control 4
	Special features 5
	Names and functions of parts 6
	Main Unit 6
	Remote control unit 7
	Setting up the system 8
Connecting audio components 9	
Connecting video components 10	
Digital connections 11	
Connecting a DVD player (6-channel input) 12	
Connecting the speakers 13	
Connecting the terminals 14	
Connecting the antennas 14	
Connecting the system control 15	
Preparing for surround sound 16	
Speaker settings 16	
Operations	Normal playback 18
	Preparing for playback 18
	Listening to a source component 19
	Adjusting the sound 19
	Recording 20
	Recording audio (analog sources) 20
	Recording video 20
	Recording audio (digital sources) 20
	Listening to radio broadcasts 21
	Tuning radio stations 21
Presetting radio stations manually 22	
Receiving preset stations 22	
Receiving preset stations in order (P.Call) 22	
Ambience effects 23	
Surround modes 23	
Surround play 25	
DVD 6-channel playback 26	
Convenient functions 26	
Remote Control	Basic remote control operations for other components 28
	Registering setup codes for other components 28
	Searching for your code 28
	Checking the codes 28
	Re-assigning device keys 29
	Operating other components 29
	Setup code chart 30
	CASSETTE deck, CD player & MD recorder operations 34
	Other components' operations 35
	Additional Information
 Specifications 39	

Unpacking

Unpack the unit carefully and make sure that all accessories are present.

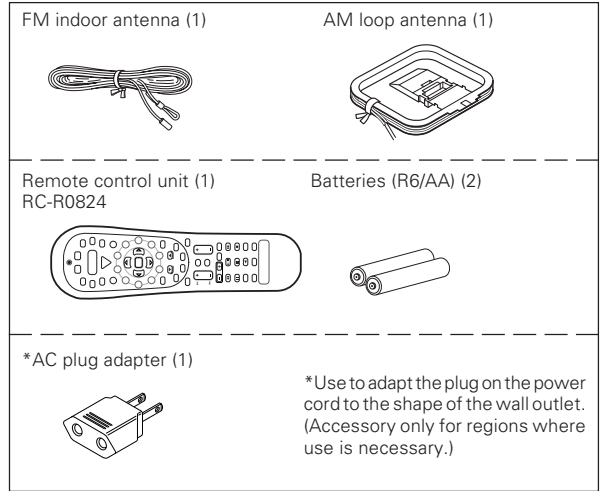

If any accessories are missing, or if the unit is damaged or fails to operate, notify your dealer immediately. If your unit was shipped to you directly, notify your shipper immediately. Kenwood recommend that you retain the original carton and packing materials in case you need to move or ship the unit in the future.

Keep this manual handy for future reference.

Maintenance of the unit

When the front panel or case becomes dirty, wipe with a soft, dry cloth. Do not use thinner, benzine, alcohol, etc. for these agents may cause discoloration.

In regard to contact cleaner

Do not use contact cleaner because it could cause a malfunction. Be specially careful not to use contact cleaners containing oil, for they may deform the plastic component.

Preparing the remote control

Loading the batteries

- ❶ Remove the cover.
- ❷ Insert the batteries.



- ❸ Close the cover.

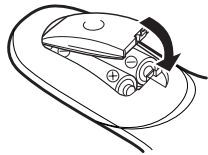

- Insert two AA-size (R6) batteries as indicated by the polarity markings.

Operation

When the **STANDBY** indicator is lit, the power turns ON when you press the **POWER RCVR** key on the remote control. When the power comes ON, press the key you want to operate.

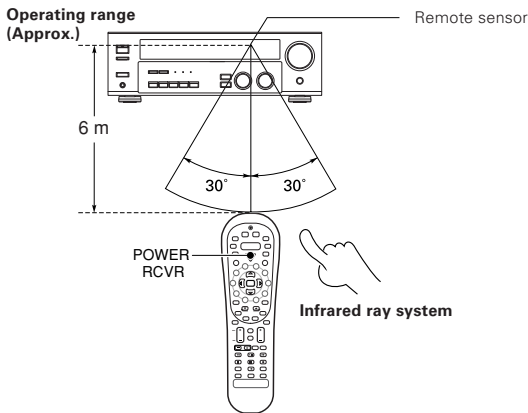

- When pressing more than one remote control key successively, press the keys securely by leaving an interval of 1 second or more between keys.

Notes

1. The supplied batteries may have shorter lives than ordinary batteries due to use during operation checks.
2. When the remote-controllable distance gets shorter than before, replace both batteries with new ones.
3. Placing the remote sensor in direct sunlight, or in direct light from a high frequency fluorescent lamp may cause a malfunction. In such a case, change the location of the system installation to prevent malfunction.

Channel space switching

(Except for the U.S.A., Canada and Australia)

The space between radio channels has been set to the one that prevails in the area to which the system is shipped. However, if the current channel space setting does not match the setting in the area where the system is to be used, for instance when you move from area 1 or area 2 shown in the following table or vice versa, proper reception of AM/FM broadcasts cannot be expected. In this case, change the channel space setting in accordance with your area by referring to the following table.

Area		CHANNEL Space Frequency
1.	U.S.A., Canada and South American countries	FM: 100 kHz AM: 10 kHz
2.	Other countries	FM: 50 kHz AM: 9 kHz

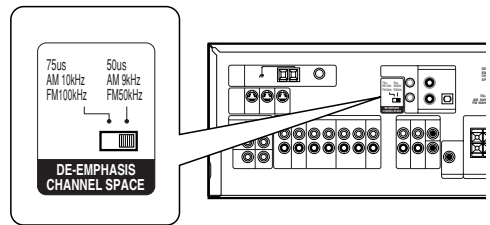

Turn the power OFF by pressing the **POWER** key before moving the switch level. Move the switch lever to match your area with a small screwdriver or other pointed tool, then turn the power ON again.

Memory back up function

Please note that the following items will be deleted from the unit's memory if the power cord is disconnected from the AC outlet for approximately 1 day.

- Power mode.
- Input selector settings.
- Picture output.
- Speaker ON/OFF.
- Volume level.
- BASS, TREBLE, INPUT level.
- TONE ON/OFF.
- LOUDNESS ON/OFF.
- Dimmer level.
- MD/TAPE settings.
- Listen mode setting.
- SP SYSTEM.
- Speaker settings.
- SUBWOOFER ON/OFF.
- SW RE-MIX ON/OFF.
- Distance setting timer.
- Input mode setting.
- Midnight mode setting.
- PRO LOGIC II mode setting.
- Broadcast band.
- Frequency setting.
- Preset stations.
- Tuning mode.
- ACTIVE EQ mode.
- DSP mode.

For the U.S.A.

FCC WARNING

This equipment may generate or use radio frequency energy. Changes or modifications to this equipment may cause harmful interference unless the modifications are expressly approved in the instruction manual. The user could lose the authority to operate this equipment if an unauthorized change or modification is made.

NOTE:

This equipment has been tested and found to comply with the limits for a Class B digital device, pursuant to Part 15 of the FCC Rules. These limits are designed to provide reasonable protection against harmful interference in a residential installation. This equipment may cause harmful interference to radio communications, if it is not installed and used in accordance with the instructions. However, there is no guarantee that interference will not occur in a particular installation. If this equipment does cause harmful interference to radio or television reception, which can be determined by turning the equipment off and on, the user is encouraged to try to correct the interference by one or more of the following measures:

- Reorient or relocate the receiving antenna.
- Increase the separation between the equipment and receiver.
- Connect the equipment into an outlet on a circuit different from that to which the receiver is connected.
- Consult the dealer or an experienced radio / TV technician for help.

For the U.S.A.

Note to CATV system installer

This reminder is provided to call the CATV system installer's attention to Article 820-40 of the NEC that provides guidelines for proper grounding and, in particular, specifies that the cable ground shall be connected to the grounding system of the building, as close to the point of cable entry as practical.



As an ENERGY STAR® Partner, Kenwood Corporation has determined that this product meets the ENERGY STAR® guidelines for energy efficiency. This product can save energy. Saving energy reduces air pollution and lowers utility bills.

Special features

True home theater sound

This receiver incorporates a wide variety of surround modes to bring you maximum enjoyment from your video software. Select a surround mode according to your equipment or the software you are going to play and enjoy! — [23]

Dolby Digital and Dolby Digital EX

The DOLBY DIGITAL mode lets you enjoy full digital surround from software processed in the Dolby Digital format. Dolby Digital provides up to 5.1 channels of independent digital audio for better sound quality and more powerful presence than conventional Dolby Surround. As for Dolby Digital EX, it creates six full-bandwidth output channels from the 5.1 channel sources. This is done using a matrix decoder that derives three surround channels from the two in the original recording. For best result, Dolby Digital EX should be used with movie soundtracks recorded with Dolby Digital Surround EX.

Dolby PRO LOGIC II

DOLBY PRO LOGIC II, whilst totally compatible with its predecessor PRO LOGIC, provides greater advantages in surround sound. It allows user to enjoy the conventional stereo or Dolby Surround with a convincing "5.1 like" presentation. PRO LOGIC II offers special features for controlling the overall spatial, dimensionality and frontal sound field imaging. PRO LOGIC II produces an impressive surround sound from video software marked  and three-dimensional space from music CD. When listening to music, you will be able to enjoy the experience of sheer STEREO surround sound.

DTS

DTS (Digital Theater System) is a 5.1 channel digital audio format that provides five full-spectrum channels and one low-frequency (subwoofer) channel for unprecedented clarity, optimum channel separation and a (wide) dynamic range.

In the DTS mode, the 5.1 channel digital input from a DTS CD, LD or DVD disc (carrying the "DTS" marking) can be played in Digital Surround.

Important:

When a DTS disc is played on a CD, LD or DVD player, noise may be output from the analog output. It is recommended that you connect the digital output of the player to the digital input of this unit.

DSP surround modes

The DSP (Digital Signal Processor) used for this receiver incorporates a variety of high quality adjustable sound fields, like "ARENA", "JAZZ CLUB", "THEATER", "STADIUM" and "DISCO". It is compatible with almost any kind of program source.

DVD 6-channel input

If you own a DVD player equipped with 6-channel output, this receiver allows you to obtain the full surround sound impact of DVD source material featuring multi-channel encoding. Since the source signals are digital and each channel is input independently, the resulting ambience is far superior to what can be achieved with conventional surround sound systems.

ACTIVE EQ

ACTIVE EQ mode will produce a more dynamic sound quality in any condition. You can enjoy a more impressive sound effect when ACTIVE EQ is turned on during Dolby Digital and DTS playback.

Universal IR (InfraRed) remote control

In addition to the basic receiver, the remote control supplied with this receiver can also operate almost all of your remote controllable audio and video components. Just follow the simple setup procedure to register the components you have connected.

Names and functions of parts

Main Unit

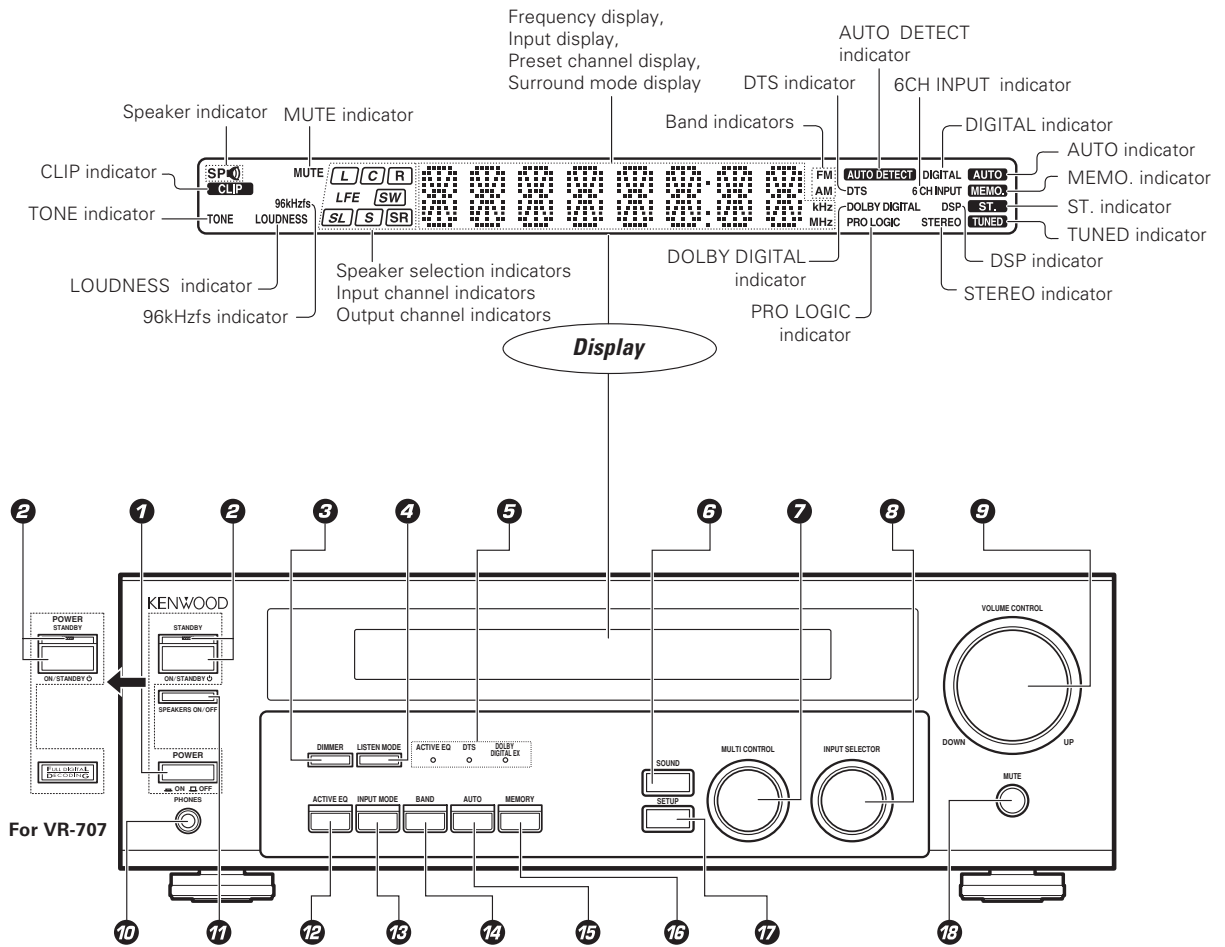

- | | | |
|--|---|--|
| <p>1 POWER ON/OFF key (For KRF-V6070D) - [16]
Use to turn the main power ON/OFF.</p> <p>2 ON/STANDBY \downarrow key (For KRF-V6070D) - [16]
Use to switch the power ON/STANDBY when the POWER is turned ON.
STANDBY indicator</p> <p>2 POWER ON/STANDBY \downarrow key (For VR-707) - [16]
Use to turn the power ON/STANDBY.
STANDBY indicator</p> <p>3 DIMMER key - [20]
Use to select the REC MODE.
Use to adjust the brightness of the display. - [27]</p> <p>4 LISTEN MODE key - [25]
Use to select the listening mode.</p> | <p>5 Surround LED (light-emitting diode) indicators</p> <p>ACTIVE EQ mode LED indicator - [20]
Lights when the receiver is in the ACTIVE EQ mode.</p> <p>DTS mode LED indicator - [25]
Lights when the receiver is in the DTS mode.</p> <p>DOLBY DIGITAL EX mode LED indicator - [25]
Lights when the receiver is in the Dolby Digital EX mode.</p> <p>6 SOUND key - [26]
Use to adjust the sound quality and the ambience effects.</p> <p>7 MULTI CONTROL knob - [16]
Use to control a variety of settings.</p> <p>8 INPUT SELECTOR knob - [19]
Use to select the input sources.</p> <p>9 VOLUME CONTROL knob - [19]
10 PHONES jack - [20]
Use for headphone listening.</p> | <p>11 SPEAKERS ON/OFF key - [18]
Use to turn the speakers ON/OFF.</p> <p>12 ACTIVE EQ key - [19]
Use to select ACTIVE EQ setting.</p> <p>13 INPUT MODE key - [8]
Use to switch between full auto, digital and analog inputs.</p> <p>14 BAND key - [21]
Use to select the broadcast band.</p> <p>15 AUTO key - [21]
Use to change "TAPE" indication to "MD".
Use to select the auto tuning mode. - [21]</p> <p>16 MEMORY key - [22]
Use to store radio stations in the preset memory.</p> <p>17 SETUP key - [16]
Use to select the speakers' settings etc.</p> <p>18 MUTE key - [20]
Use to temporarily mute the sound.</p> |
|--|---|--|

Standby mode

While the standby indicator is lit, a small amount of power is supplied to the system to back-up the memory. This is called standby mode. Under the condition, the system can be turned ON by the remote control unit.

Connection at POWER ON/OFF key (for KRF-V6070D)

The power in this equipment will not be completely cut off from the AC wall outlet when the main switch is turned OFF.

Remote control unit

This remote control unit can be used not only for Kenwood products but also for non-Kenwood products by setting the appropriate manufacturer's setup codes.

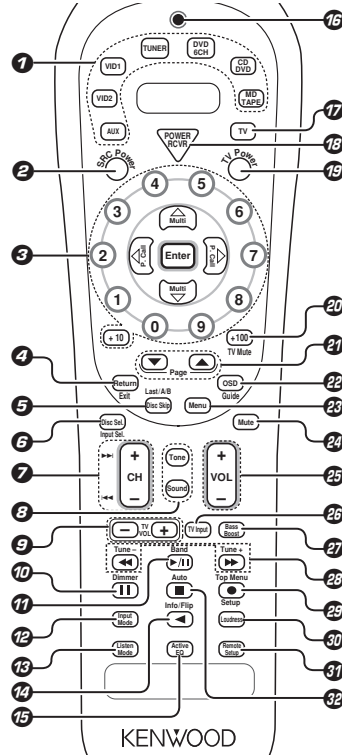

If the name of a function is different on the receiver and on the remote control, the name of the remote control key in this manual is indicated in parentheses.

1 Source keys (AUX, VID2, VID1, TUNER, DVD/6CH, CD/DVD, MD/TAPE) — [28]

When press and hold for more than 3 seconds, they are used to select the registered components.

Input Selector keys (AUX, VID2, VID1, TUNER, DVD/6CH, CD/DVD, MD/TAPE) — [19]

When press and release in less than 3 seconds, they are used to select the input sources.

2 SRC (source) Power key

Use to turn the other source components on and off.

3 Numeric keys — [26]

Provide functions identical to those of the original remote control supplied with the component you are controlling.

Multi (multi control) Δ/∇ keys — [16]

Use to control a variety of settings.

P.Call \langle/\rangle keys — [22]

If tuner is selected as the input source, these keys function as preset channel call keys.

Enter key

Use to operate other components.

4 Return key

Use to operate the DVD component.

Exit key

Use to operate other components.

5 Disc Skip key

If CD is selected as the input source, this key functions as the multi-CD player disc skip key.

Last/A/B key

If TAPE is selected as the input source, this is A and B deck of a double cassette deck.

Use to operate other components.

6 Disc Sel. key

Use to operate other components.

Input Sel. key

Use to operate other components.

7 CH +/- keys

Use to select the channels.

◀◀/▶▶ keys

If CD, MD or DVD is selected as the input source, these keys function as skip keys.

8 Tone key — [19]

Use to switch the status of TONE control.

Sound key — [26]

Use to adjust the sound quality and ambience effects.

9 TV VOL +/- keys

Use to adjust the TV's volume.

10 II key

Use to operate other components.

— [27]

Dimmer key

Use to adjust the brightness of the display.

11 \triangleright /II key

If CD is selected as the input source, this key functions as the play/pause key. If MD or TAPE is selected as the input source, this key functions as the play key.

— [21]

Band key

Use to select the broadcast band.

12 Input Mode key — [8]

Use to switch between full auto, digital and analog inputs.

13 Listen Mode key — [25]

Use to select the listening mode.

14 \blacktriangleleft key

If TAPE is selected, this key functions as reverse play key.

Info/Flip key

Use to operate other components.

15 Active EQ key — [19]

Use to select ACTIVE EQ setting.

16 LED (light-emitting diode) indicator

Blinks to show that signals are being transmitted.

17 TV key

Use to select the TV equipment.

18 POWER RCVR (receiver) key — [16]

Use to turn the receiver on and off.

19 TV Power key

Use to turn the TV on and off.

20 +100 key

Use to select the disc number with the multi-CD player.

TV Mute key

Use to temporarily mute the TV sound.

21 Page ∇/Δ keys

Use to operate other components.

22 OSD (on screen display) key

Use to operate the DVD component.

Guide key

Use to operate other components.

23 Menu key

Use to operate other components.

24 Mute key — [20]

Use to temporarily mute the sound.

25 VOL +/- keys

Use to adjust the receiver's volume.

26 TV Input key

Use when in TV operation.

27 Bass Boost key — [19]

Use to select the maximum adjustment setting for the low frequency range.

28 $\blacktriangleleft/\blacktriangleright$ key

If CD, MD or TAPE is selected as the input source, these keys function as search key.

Tune +/- key

Use to operate the tuner mode.

29 \bullet key

If MD or TAPE is selected, this key functions as record key.

If VCR is selected, this key functions as record key when it is pressed twice sequentially.

Top Menu key

Use to operate other components.

Setup key — [16]

Use to select the speakers' settings etc.

30 Loudness key — [19]

Use to switch the status of LOUDNESS.

31 Remote Setup key

Use to register other components.

32 \blacksquare key

If CD, MD or TAPE is selected as the input source, this key functions as the stop key.

Auto key — [21]

Use to select the auto tuning mode.

Setting up the system

Make connections as shown in the following pages. When connecting the related system components, be sure to refer to the instruction manuals supplied with the components you are connecting. Do not connect the power cord to a wall outlet until all connections are completed.

Notes

1. Be sure to insert all connection cords securely. If their connections are imperfect, the sound may not be produced or there will be noise interference.
2. Be sure to remove the power cord from the AC outlet before plugging or unplugging any connection cords. Plugging/unplugging connection cords without disconnecting the power cord can cause malfunctions and may damage the unit.
3. Do not connect power cords from components whose power consumption is larger than what is indicated on the AC outlet at the rear of this unit.

Analog connections

Audio connections are made using RCA pin cords. These cables transfer stereo audio signal in an "analog" form. This means the audio signal corresponds to the actual audio of two channels. These cables usually have 2 plugs at each end, red for the right channel and white for the left channel. These cables are usually packed together with the source unit, or are available at your local electronics retailer.

Microcomputer malfunction

If operation is not possible or an erroneous display appears, even though all connections have been made properly, reset the microcomputer by referring to "In case of difficulty". - [37]

Input mode settings

CD/DVD, VIDEO2 and DVD/6CH inputs each include jacks for digital audio input and analog audio input.

After completing connections and turning on the receiver, follow the steps below.

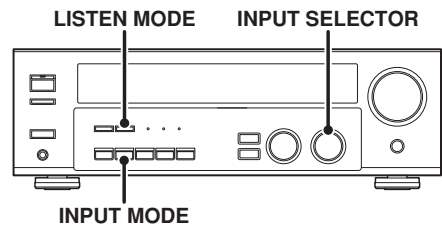

➊ Use the **INPUT SELECTOR** knob to select **CD/DVD, VIDEO2, DVD/6CH**.

➋ Press the **INPUT MODE** key.

Each press switches the setting as follows:

In DTS play mode

- ➊ **F-AUTO** (digital input, analog input)
- ➋ **D-MANUAL** (digital input)

In CD/DVD, VIDEO2, DVD/6CH play mode

- ➊ **F-AUTO** (digital input, analog input)
- ➋ **D-MANUAL** (digital input)
- ➌ **6CH INPT** (DVD/6CH input)
- ➍ **ANALOG** (analog input)

Digital input:

Select this setting to play digital signals from a DVD, CD, or LD player.

Analog input:

Select this setting to play analog signals from a cassette deck, VCR, or record player.

Auto detect:

In "**F-AUTO**" (full auto) mode (**AUTO DETECT** and **DIGITAL** indicators light up), the receiver detects the digital or analog input signals automatically. Priority is given to digital signal during input mode selection. The receiver will select the input mode and listening mode automatically during playback to match the type of input signal (Dolby Digital, PCM, DTS) and the speaker setting. The initial factory setting is full auto.

To keep the receiver set to the currently selected listening mode, use the **INPUT MODE** key to select "**D-MANUAL**" (digital manual). However, even when this setting is selected, there may be cases in which the listening mode is selected automatically to match a Dolby Digital source signal depending on the combination of listening mode and source digital.

In **D-MANUAL** mode, if the audio reproduction stops in the middle due to change in the input signals etc, press the **LISTEN MODE** key. If the **INPUT MODE** key is pressed quickly, sound may not be produced. Press the **INPUT MODE** key again.

Connecting audio components

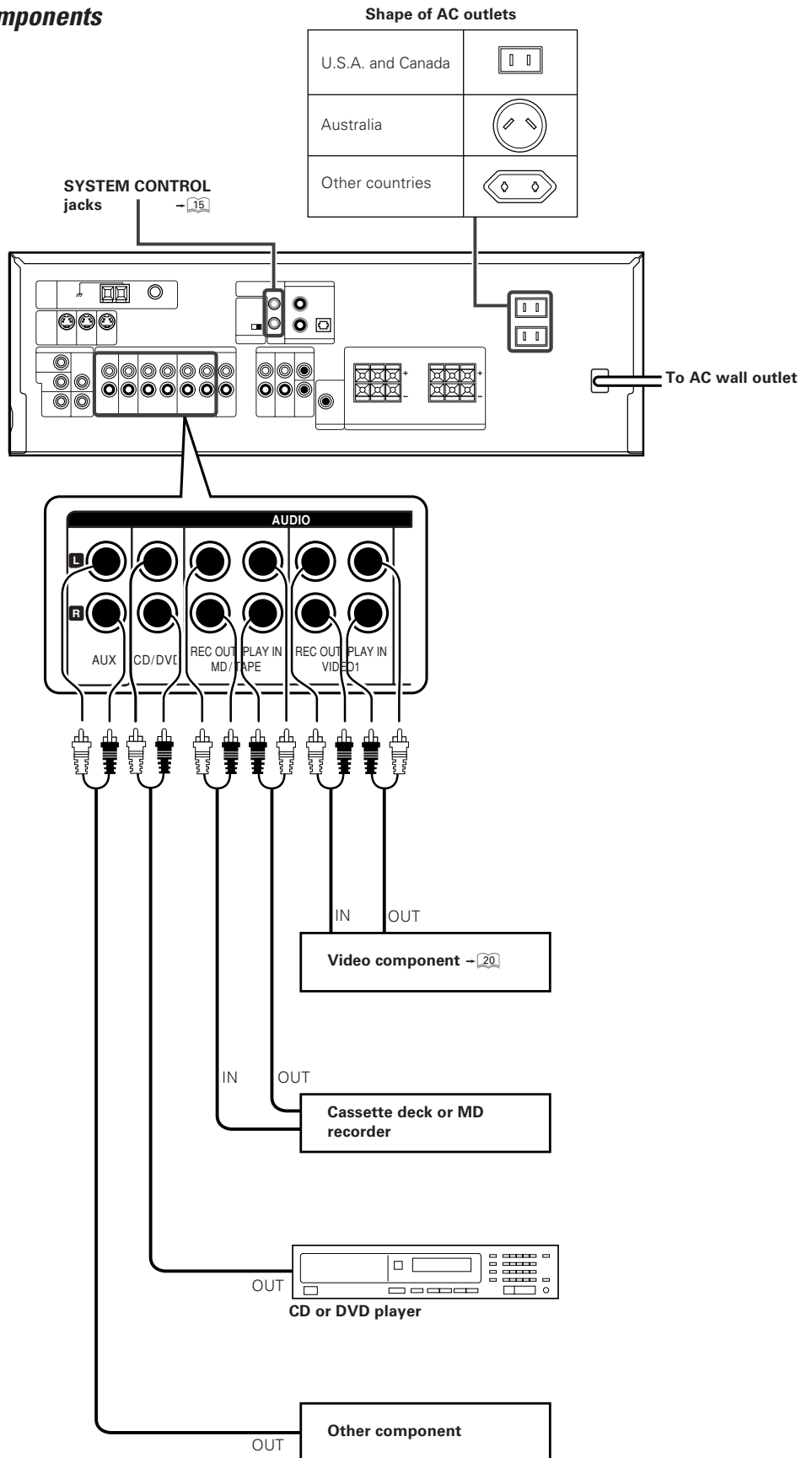

Connecting video components

About the S-VIDEO jacks

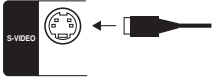

Use the S-VIDEO jacks to make connections to video components with S-VIDEO IN/OUT jacks.

- If you use the S-VIDEO jacks to connect your video playback components, be sure to use the S-VIDEO jacks when connecting your monitor and video recording components.

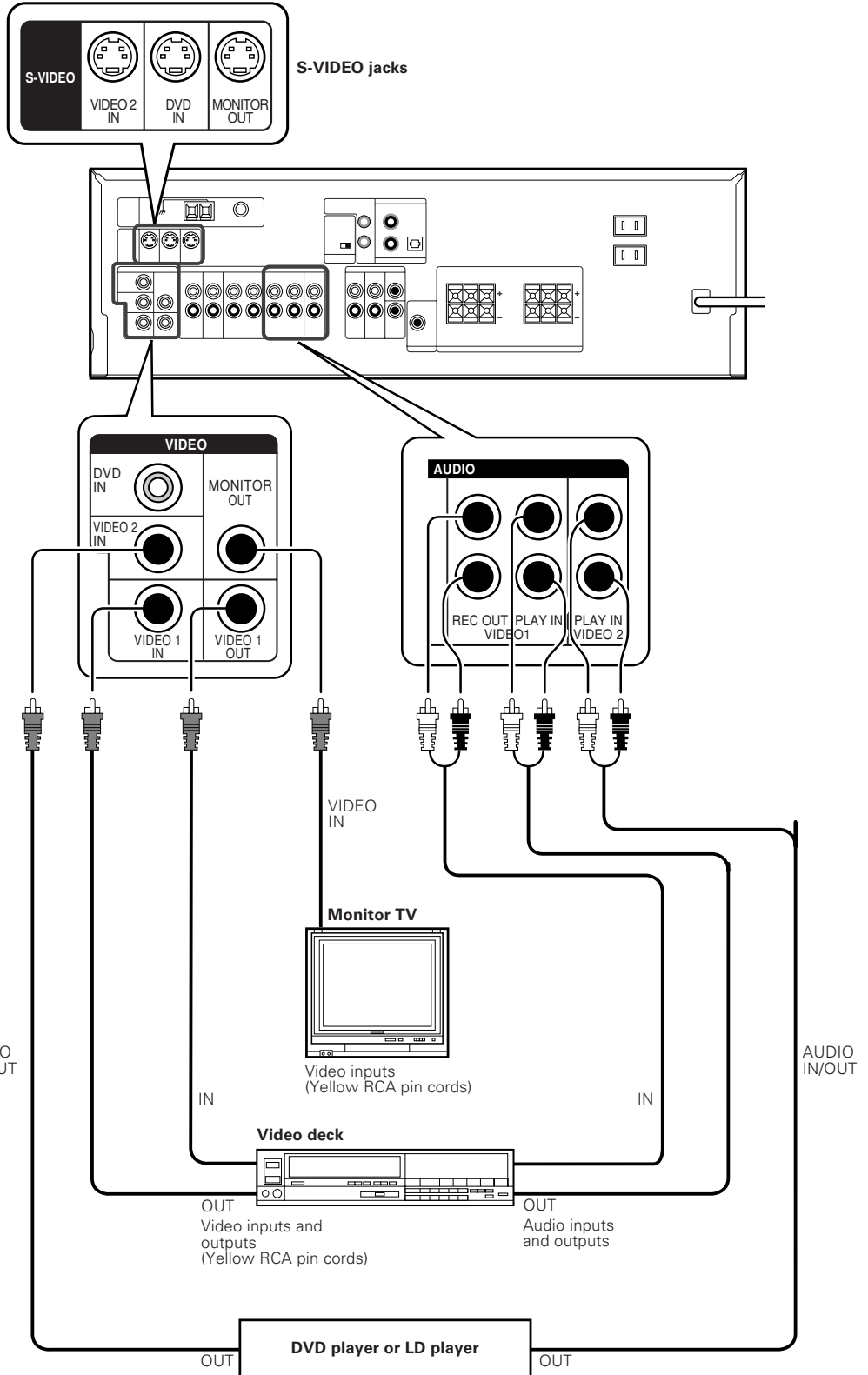

A video component with digital audio outputs should be connected to the VIDEO 2 jacks.

Digital connections

The digital in jacks can accept DTS, Dolby Digital, or PCM signals. Connect components capable of outputting DTS, Dolby Digital, or standard PCM (CD) format digital signals.

If you have connected any digital components to the receiver, be sure to read the "Input mode settings" section carefully.

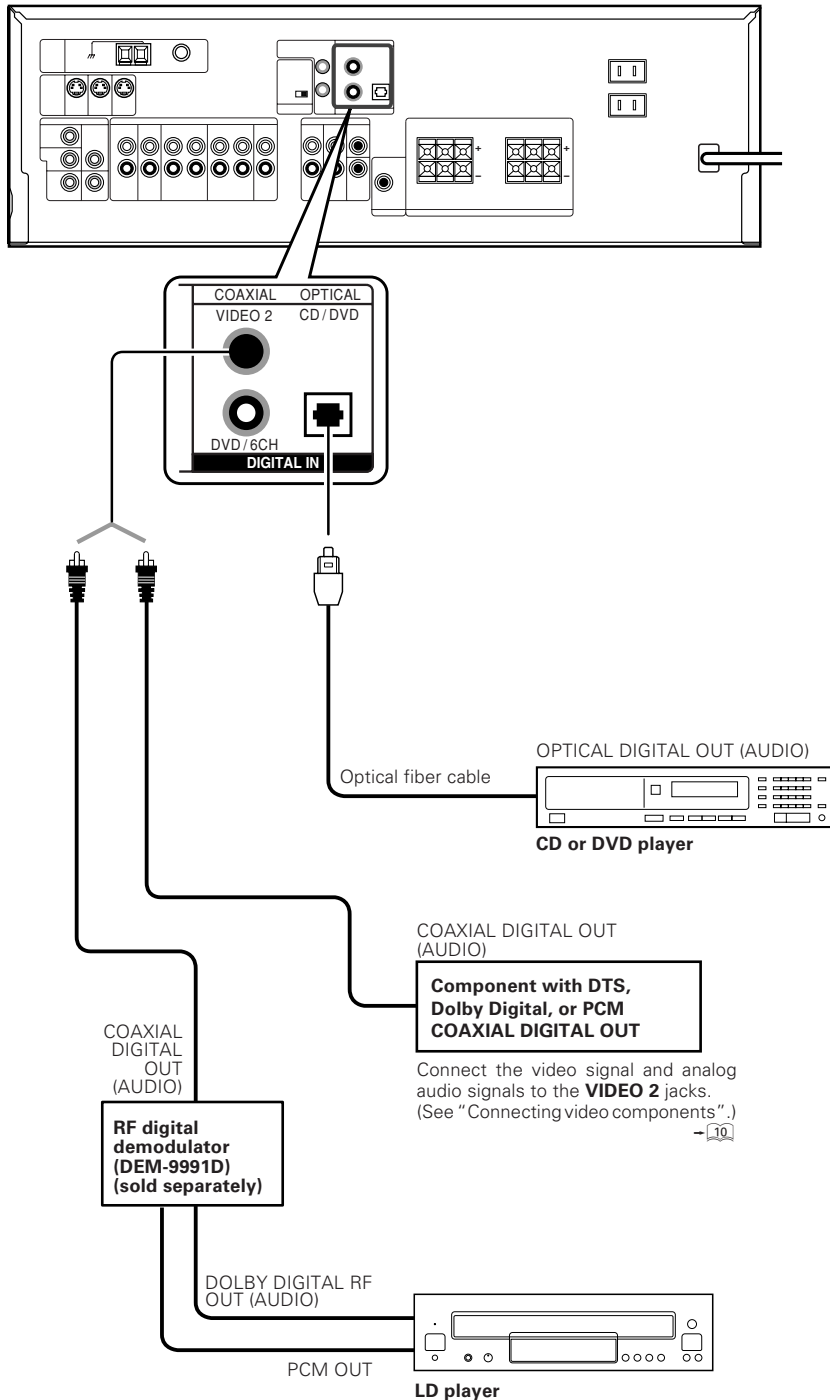

To connect an LD player with a DIGITAL RF OUT, connect the LD player to the KENWOOD RF digital demodulator (DEM-9991D). Next, connect the DIGITAL OUT jacks of the demodulator to the DIGITAL IN jacks of the receiver. Connect the video signal and analog audio signals to the VIDEO 2 jacks. (See "Connecting video components".)

Connecting a DVD player (6-channel input)

If you have connected a DVD player to the receiver with digital connection, be sure to read the "Input mode settings" section carefully.

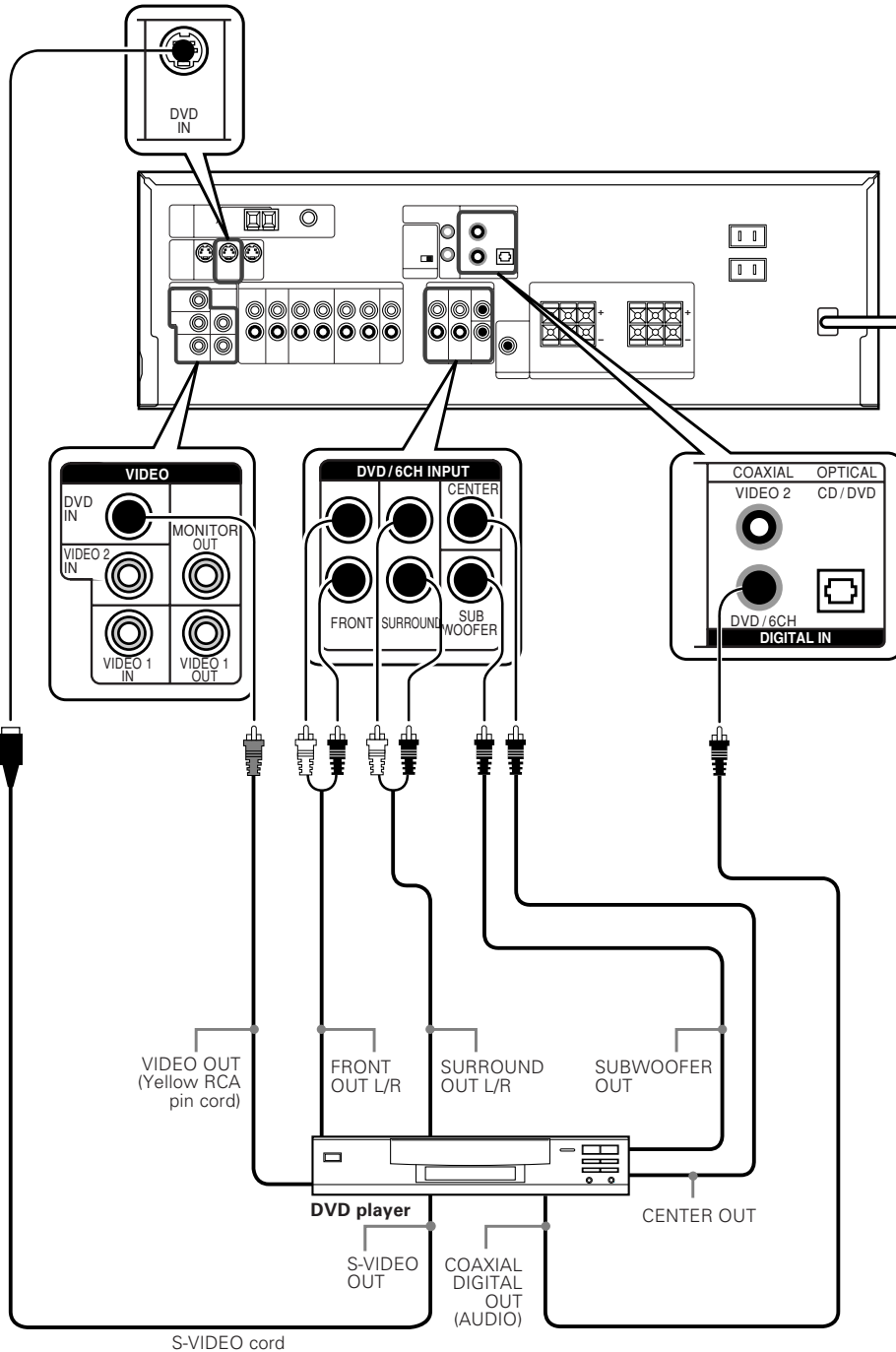

CAUTION

Be sure to adhere to the following, or proper ventilation will be blocked causing damage or fire hazard.

- Do not place any object impairing heat radiation onto the top of the unit.
- Leave a space around the unit (from the largest outside dimension including projection) equal or greater than, shown below.

Top panel : 50 cm

Side panel : 10 cm

Back panel : 10 cm

Connecting the speakers

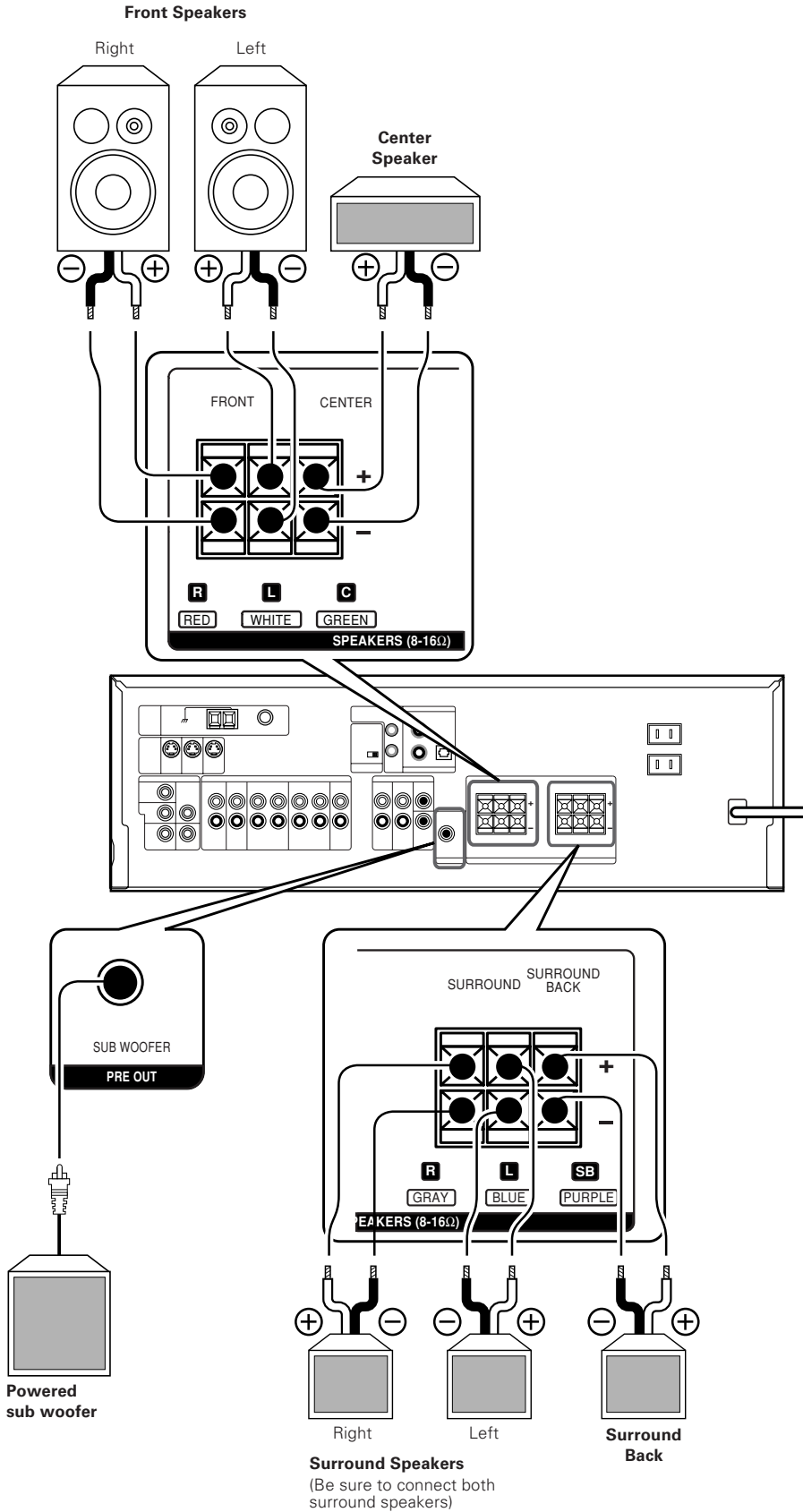

Connecting the terminals

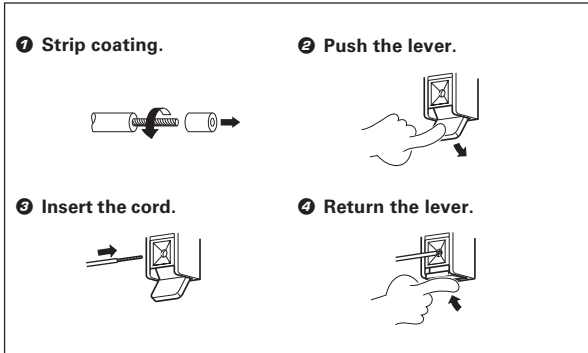

- Never short circuit the + and – speaker cords.
- If the left and right speakers are connected inversely or the speaker cords are connected with reversed polarity, the sound will be unnatural with ambiguous acoustic imaging. Be sure to connect the speakers correctly.

Speaker impedance

After confirming the speaker impedance indications printed on the rear panel of the receiver, connect speakers with matching impedance ratings. Using speakers with a rated impedance other than that indicated on the rear panel of the receiver could result in malfunctions or damage to the speakers or receiver.

Connecting the antennas

AM loop antenna

The supplied loop antenna is for use indoors. Place it as far as possible from the receiver, TV set, speaker cords and power cord, and adjust the direction for best reception.

AM antenna terminal connections

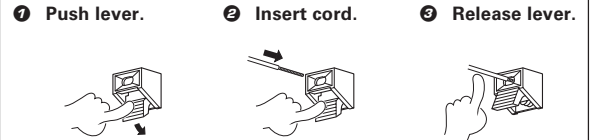

FM indoor antenna

The supplied indoor antenna is for temporary use only. For stable signal reception we recommend using an outdoor antenna. Disconnect the indoor antenna when you connect one outdoors.

FM antenna terminal connections

Insert cord.



FM outdoor antenna

Lead the 75Ω coaxial cable connected to the FM outdoor antenna into the room and connect it to the **FM 75Ω** terminal.

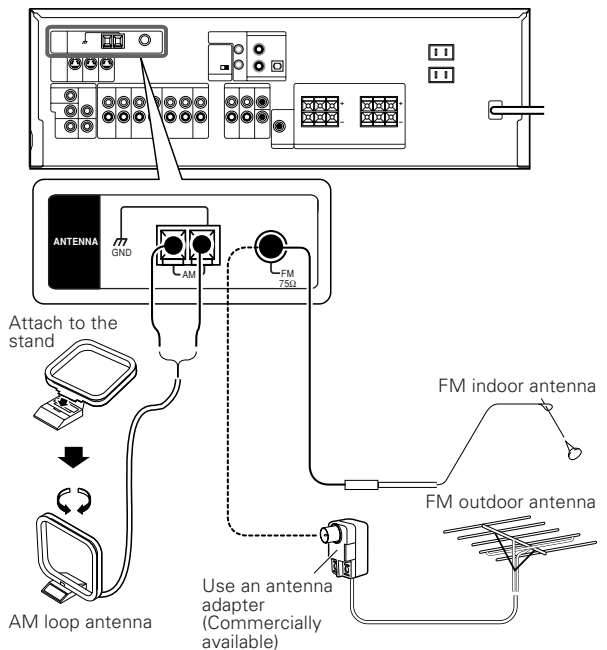

Connecting the system control

Connecting system control cords after connecting a KENWOOD audio component system lets you take advantage of convenient system control operations.

This unit is compatible only with the [SL-16] mode. The system control operation is not available if the unit is connected in the [XS8], [XS], or [XR] connection mode.

If your component has the mode select switch, set the connected components to the [SL16] mode.

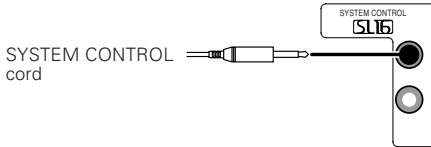

- You may connect the system control cord to either the up or down jack.

EXAMPLE: [SL16] mode connections

The underlined portion represents the setting of the system control mode.

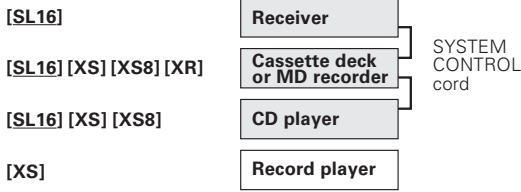

- In order to take advantage of the system control operations, the components must be connected to the correct jacks. To use a CD player it must be connected to the CD jacks. To use a cassette deck (or MD recorder) it must be connected to the MD/TAPE jacks. When using more than one CD player (etc.) only the one connected to the specified jacks may be connected for system control.
- Some CD players and cassette decks are not compatible with the [SL16] system control mode. Do not make system connections with equipment that is not [SL16] compatible.
- Some MD players are not system control compatible. You cannot make system control connections to this kind of equipment.

Notes

- [SL16] equipment cannot be combined with [XR], [XS], and [XS8] equipment for system operations. If your equipment consists of this kind of combination, please do not connect any system control cords. Even without system control cords, normal operations can be carried out without affecting performance.
- Do not connect system control cords to any components other than those specified by KENWOOD. It may cause a malfunction and damage your equipment.
- Be sure the system control plugs are inserted all the way in to the system control terminals.

SYSTEM CONTROL OPERATIONS

Remote Control

Lets you operate this unit with the system remote supplied with the receiver.

Automatic Operation

When you start playback from a source component, the input selector on this unit switches to that component automatically.

Synchronized Recording

Lets you synchronize recording with the start of playback when recording from CD, MD or analog discs.

Speaker placement

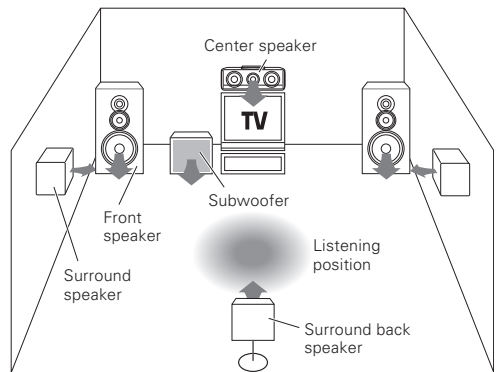

Front speakers : Place to the front left and right of the listening position. Front speakers are required for all surround modes.

Center speaker : Place front and center. This speaker stabilizes the sound image and helps recreate sound motion. Required for surround playback.

Surround speakers : Place to the direct left and right, or slightly behind, the listening position at even heights, approximately 1 meter above the ears of the listeners. These speakers recreate sound motion and atmosphere. Required for surround playback.

Subwoofer : Reproduces powerful deep bass sounds.

Surround back speaker : Place the speaker directly at the rear of the listening position. The optimum position depends mainly on the room condition.

- Although the ideal surround system consists of all the speakers listed above, if you don't have a center speaker or a subwoofer, you can divide those signals between the available speakers in the speaker settings steps to obtain the best possible surround reproduction from the speakers you have available. → 16

Preparing for surround sound

Speaker settings

To enable you to obtain optimum enjoyment from the receiver's listening modes, make sure to complete the speaker settings (subwoofer, front, center, and surround speakers) as described below.

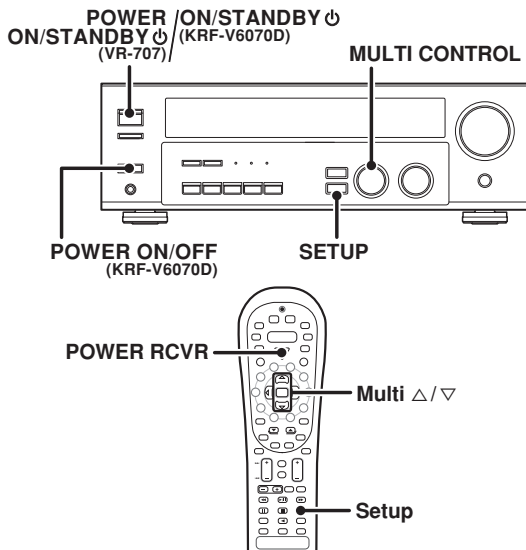

- 1 Turn on the power to this receiver by pressing **POWER ON/STANDBY** (for VR-707) or **POWER ON/OFF and ON/STANDBY** (for KRF-V6070D) or **POWER RCVR** key.
- 2 For the remote control, press and hold the **TUNER** key for more than 3 seconds to switch to receiver mode.
- 3 Press the **SETUP** key to enter the **SETUP** mode and use the **MULTI CONTROL** knob or **Multi Δ/∇** keys for the following displays.

- 1 SP SETUP
- 2 TESTTONE
- 3 DISTANCE
- 4 EXIT

The flow of the SETUP is as follows;

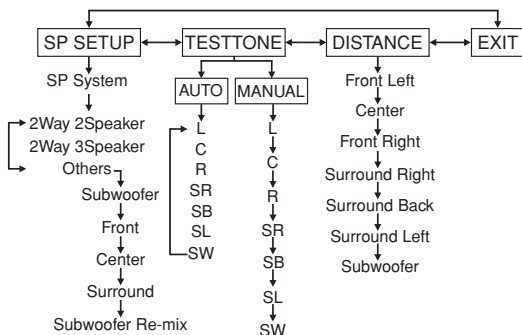

4 Select a speaker system.

- 1 Select **SP SETUP** and press the **SETUP** key again so that the speaker system indication "**SP SYSTEM**" scrolls across the display.

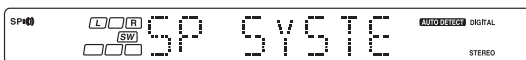

2 Use the MULTI CONTROL knob or Multi Δ/∇ keys to select the speaker system setting.

- 1 **2WAY 2SPKR** : For selected Kenwood speaker – for example, KS-307HT.
- 2 **2WAY 3SPKR** : For selected Kenwood speaker – for example, KS-707HT.
- 3 **OTHERS** : For general speakers.

- The selection of 2WAY 2SPKR or 2WAY 3SPKR should only be used with 6 channels speaker system setting.
- When the setting 2WAY 2SPKR or 2WAY 3SPKR is selected, the procedure skips to step 5.

3 For general speaker setting, use the MULTI CONTROL knob or Multi Δ/∇ keys to select OTHERS and press the SETUP key again.

- The subwoofer setting indication "SUBW ON" appears.



4 Use the MULTI CONTROL knob or Multi Δ/∇ keys to select the appropriate subwoofer setting.

- 1 **SUBW ON** : Subwoofer setting mode to the receiver is ON.
- 2 **SUBW OFF** : Subwoofer setting mode to the receiver is OFF.

- The initial setting is "SUBW ON".
- When the setting "SUBW OFF" is selected, the front speakers are automatically set to "FRNT LRG" and the procedure skips to step 7.
- Before step 7, press the **SETUP** key to accept the setting.
- When subwoofer output sound is required, select "FRNT NML".

5 Press the SETUP key to accept the setting.

- The front speakers setting indication "FRNT NML" appears.

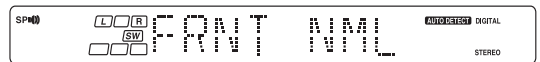

6 Use the MULTI CONTROL knob or Multi Δ/∇ keys to select the appropriate front speakers setting.

- 1 **FRNT NML** (normal) : Average size front speakers are connected to the receiver.
- 2 **FRNT LRG** (large) : Large front speakers are connected to the receiver.

- For "FRNT LRG" selection, no sound will be heard from subwoofer speaker even when it is set to ON. However, if you select "SW RE-MIX ON" when subwoofer is selected, you will be able to hear sound from the subwoofer.
- When in STEREO mode, the sound goes directly to front speaker.

7 Press the SETUP key to accept the setting.

- The center speaker setting indication "CNTR NML" appears.

8 Use the MULTI CONTROL knob or Multi Δ/∇ keys to select the appropriate center speaker setting.

If you have selected "LRG" as the front speakers setting,

- 1 **CNTR NML** (normal) : An average size center speaker is connected to the receiver.
- 2 **CNTR LRG** (large) : A large center speaker is connected to the receiver.
- 3 **CNTR OFF** : Center speaker setting mode to the receiver is OFF.

If you have selected "NML" as the front speakers setting,

- 1 **CNTR ON** : Center speaker setting mode to the receiver is ON.
- 2 **CNTR OFF** : Center speaker setting mode to the receiver is OFF.

9 Press the SETUP key again to accept the setting.

- The surround speaker setting indication "SURR NML" appears.

10 Use the MULTI CONTROL knob or Multi Δ/∇ keys to select the appropriate surround speaker setting.

If you have selected "LRG" as the center speaker setting,

- ① **SURR NML** (normal): Average size surround speakers are connected to the receiver.
- ② **SURR LRG** (large) : Large surround speakers are connected to the receiver.
- ③ **SURR OFF** : Surround speaker setting mode to the receiver is OFF.

If you have selected other than "LRG" as the center speaker setting,

- ① **SURR ON** : Surround speaker setting mode to the receiver is ON.
- ② **SURR OFF** : Surround speaker setting mode to the receiver is OFF.

- When the setting "SURR OFF" is selected, the procedure skips to step 11.

11 Press the SETUP key to accept the setting.

- The surround back speaker setting indication "SB" appears.

12 Use the MULTI CONTROL knob or Multi Δ/∇ keys to select the appropriate surround back speaker setting.

If you have selected "LARGE" as the surround speaker setting,

- ① **SB NORMAL** : Average size surround back speaker is connected to the receiver.
- ② **SB LARGE** : Large surround back speaker is connected to the receiver.
- ③ **SB OFF** : Surround back speaker setting mode to the receiver is OFF.



If you have selected "NORMAL" as the surround speaker setting,

- ① **SB ON** : Surround back speaker setting mode to the receiver is ON.
- ② **SB OFF** : Surround back speaker setting mode to the receiver is OFF.

13 Press the SETUP key to accept the setting.

- The surround mix setting indication "SURR MIX" appears.
- SURR MIX is when the SL and SR speakers signals are mixed to produce sound from the surround back speaker which would enable the listener to enjoy sound coming from the back.

14 Use the MULTI CONTROL knob or Multi Δ/∇ keys to select the surround mix setting.

- ① **MIX OFF** : Surround mix setting mode is OFF.
- ② **MIX ON** : Surround mix setting mode is ON.

15 Press the SETUP key again to accept the setting.

- The subwoofer re-mix setting indication "SW RE-MIX" scrolls across the display.



- If subwoofer is turned OFF, subwoofer re-mix setting is not visible.

16 Use the MULTI CONTROL knob or Multi Δ/∇ keys to select the appropriate subwoofer re-mix setting.

- ① **RMX ON** : Subwoofer re-mix set mode to the receiver is ON.
- ② **RMX OFF** : Subwoofer re-mix set mode to the receiver is OFF.

17 Press the SETUP key to accept the setting.

- The receiver enters the speaker volume level adjustment mode.
- In step 5 and 6, indications appear only for the selected channels of the speakers that require adjusting.

5 Adjust the speaker volume level.

From your usual listening position, adjust the volume levels. The volume levels from each speaker should be the same.

1 Press the SETUP key to begin TEST TONE.

The selection of AUTO/MANUAL TEST TONE is done by the MULTI CONTROL knob or Multi Δ/∇ keys.

- ① **AUTO**
- ② **MANUAL**

2 Press the SETUP key again to select either AUTO or MANUAL.

Use the MULTI CONTROL knob or Multi Δ/∇ keys to adjust the volume level of the test tone output from the speaker channel to be adjusted.

For AUTO selection, the test tone is heard from the speakers in the following sequence for 2 seconds each:

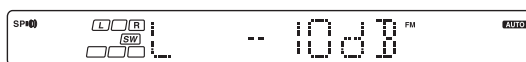
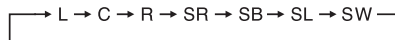

- If you change the volume level settings for the speakers while listening to music, the settings referred to on this page are also changed. → 26
- If any of the speaker is set as OFF during SP SETUP, the TEST TONE adjustment for the speaker will be skipped.

3 Press the SETUP key.

- The test tone is turned off. The receiver enters the mode for inputting the distance to the speakers.

4 For MANUAL selection, press the SETUP key each time to select the speaker channel.

6 Input the distance to the speakers.

1 Select the DISTANCE from the set up displays and press the SETUP key again.

2 Measure the distance from the listening position to each of the speakers.

Not down the distance to each of the speakers.

- Distance to Front left speaker (L) : ___ feet (meters)
- Distance to Center speaker (C) : ___ feet (meters)
- Distance to Front right speaker (R) : ___ feet (meters)
- Distance to Surround right (SR) : ___ feet (meters)
- Distance to Surround back (SB) : ___ feet (meters)
- Distance to Surround left (SL) : ___ feet (meters)
- Distance to Subwoofer (SW) : ___ feet (meters)

3 Use the MULTI CONTROL knob or Multi Δ/∇ keys to select the distance to the front speakers.

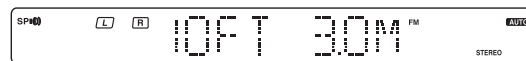

Indication in feet Indication in meters

- The allowable setting range is 1 to 30 feet (0.3m to 9.0m), adjustable in 1 foot (0.3m) increments.

4 Press the SETUP key to accept the settings.

5 Repeat steps 3 and 4 to input the distance for each of the speakers.

6 Setup is complete when the EXIT indication appears.

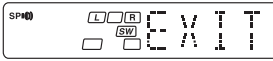

• The speakers you have selected should appear on the display. Confirm that all the speakers have been correctly selected.

7 Press the SETUP key to exit the SETUP mode.

Input level adjustment (analog sources only)

If the input level of an analog source signal is too high, the CLIP indicator will blink to indicate the source signal. Adjust the input level.

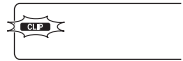

1 Use the INPUT SELECTOR knob to select the source of which the input level you want to adjust.

• You can store a separate input level for each input source.

2 Press the SOUND key repeatedly until the "INPUT" indication appears.

3 Use the MULTI CONTROL knob or Multi Δ/∇ keys to adjust the input level.



• The input level may be adjusted to any one of three settings: 0dB, -3dB, and -6dB. (The initial setting is 0dB.)

4 Press the SOUND key again to return to the input indication.

Normal playback

Preparing for playback

Some preparatory steps are needed before starting playback.

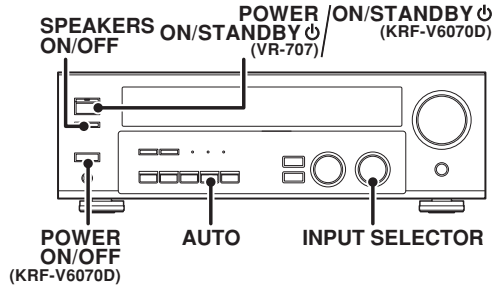

Turning on the receiver

1 Turn on the power to the related components.

2 Turn on the power to this receiver by pressing POWER ON/STANDBY ON/OFF (for VR-707) or POWER ON/OFF and ON/STANDBY ON/OFF (for KRF-V6070D) key.

Selecting the input mode

If you have selected a component connected to the CD/DVD, VIDEO2, DVD or DVD/6CH jacks, make sure that the input mode setting is correct for the type of audio signal to be used. - 8 -

Selecting MD/TAPE

Select the source name corresponding to the component connected to the MD/TAPE jacks. The initial factory setting is "TAPE". To change the source to "MD", follow the steps below:

1 Use the INPUT SELECTOR knob to select "TAPE".

2 Hold down the AUTO key for more than 2 seconds.

- The source indication changes to "MD".
- To return to the original indication, repeat procedure 2.

Setting the speaker status

The speaker indicator lights up.

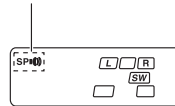

Press the SPEAKERS ON/OFF key to switch the speaker on or off.

Listening to a source component

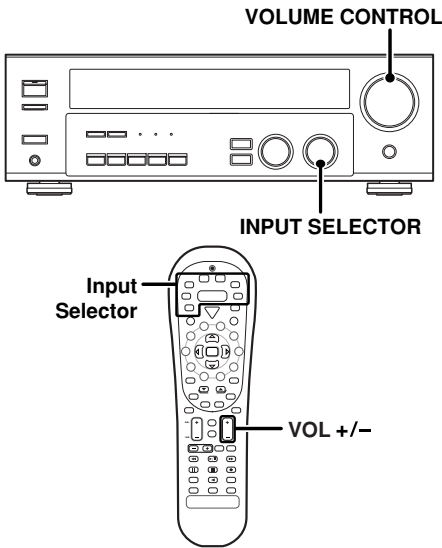

- 1 Use the **INPUT SELECTOR** knob or keys to select the source you want to listen to.

The input sources change as shown below:

- ① "AUX"
- ② "TUNER"
- ③ "CD/DVD"
- ④ "TAPE" or "MD"
- ⑤ "VIDEO1"
- ⑥ "VIDEO2"
- ⑦ "DVD/6CH"

- 2 Start playback from the selected source.

- 3 Use the **VOLUME CONTROL** knob or **VOL +/-** keys to adjust the volume.

Adjusting the sound

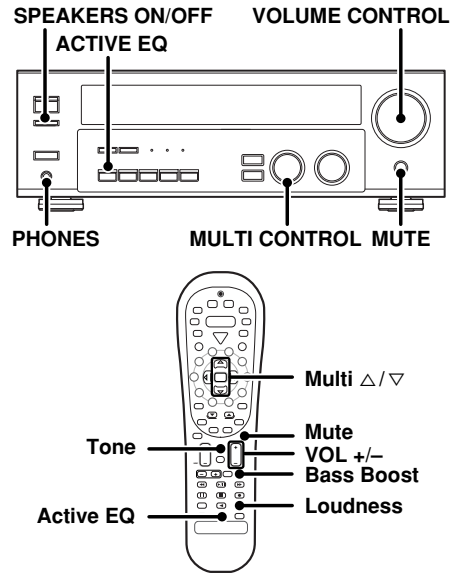

Adjusting the Tone (remote control only)

You can adjust the sound quality when the receiver is in the PCM stereo and analog stereo mode.

- 1 For the remote control, press and hold the **TUNER** key for more than 3 seconds to switch to receiver mode.
- 2 Press the **Tone** key to select the **TONE** mode.
- 3 Use the **MULTI CONTROL** knob or **Multi Δ/∇** keys to select **TONE ON/OFF**.



- 4 When in **TONE ON** selection, press the **Tone** key for the following displays.

BASS : Select this to adjust the low frequency range.
TREB : Select this to adjust the high frequency range.

- 5 Use the **MULTI CONTROL** knob or **Multi Δ/∇** keys to adjust the sound quality.

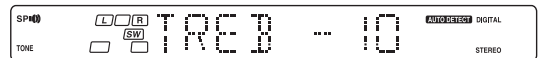

- The bass and treble levels are adjustable from -10 to +10 in 2 step increments.

Once-touch low frequency emphasis (Bass Boost) (remote control only)

You can adjust the sound quality when the receiver is in the PCM stereo and analog stereo modes.

Press the Bass Boost key.

- Press the key once to select the maximum (+10) low frequency emphasis setting.
- **TONE** will automatically be turned ON.
- This key does not function when the receiver is in the sound quality or ambience effects adjustment mode.

Switching back the previous setting

Press the **Bass Boost** key again.

Normal playback

Adjusting the Loudness mode (remote control only)

You can adjust the Loudness function which controls the low volume settings to maintain the music's richness. The adjustment can be made when the receiver is in the PCM stereo and analog stereo mode.

Press the Loudness key to turn the Loudness setting ON.

To cancel

Press the Loudness key again so that the "Loudness" indicator goes off.

Muting the sound

The MUTE key lets you mute the sound of the speakers.

Press the MUTE key.



To cancel

Press the MUTE key again so that the "MUTE" indicator goes off.

- MUTE ON can also be deactivated by turning the volume control knob.

ACTIVE EQ mode

You can enjoy a more impressive sound effect when ACTIVE EQ is turned ON during Dolby Digital and DTS playback and, when in PCM and analog stereo mode.

Press the ACTIVE EQ key for the following selections;

- 1 **ACTIVE EQ MUSIC** : Effective when listening to music. (The ACTIVE EQ LED indicator lights up.)
- 2 **ACTIVE EQ CINEMA** : Effective when watching a movie. (The ACTIVE EQ LED indicator lights up.)
- 3 **ACTIVE EQ TV** : Effective when watching TV. (The ACTIVE EQ LED indicator lights up.)
- 4 **ACTIVE EQ OFF** : The ACTIVE EQ function is turned OFF. (The ACTIVE EQ LED indicator goes off.)

- ACTIVE EQ function will not be available when REC MODE, AUTO TUNING or PRESET MEMORY is ON and during 96kHz LPCM playback.

Listening with headphones

- 1 Press the SPEAKERS ON/OFF key so that the speaker indicator goes off.

Make sure the SP indicator is turned OFF.

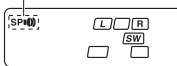

- If you turn off all of the speakers when in surround mode, the surround mode will be canceled as well, resulting in stereo playback.

- 2 Connect headphones to the PHONES jack.



- 3 Use the VOLUME CONTROL knob or VOL +/- keys to adjust the volume.

Recording

Recording audio (analog sources)

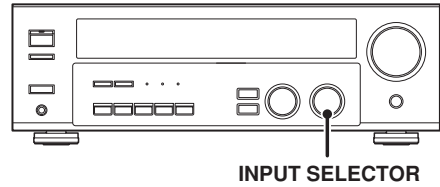

Recording a music source

- 1 Use the INPUT SELECTOR knob to select the source (other than "MD/TAPE") you want to record.
- 2 Set the MD or TAPE recorder to record.
- 3 Start playback, then start recording.

Recording video

- 1 Use the INPUT SELECTOR knob to select the video source (other than "VIDEO1") you want to record.
- 2 Set the video deck connected to VIDEO 1 to record.
 - Select the REC MODE to record a digital input source.
- 3 Start playback, then start recording.
 - Recording may not be normal for some video software. This is due to the copy guard condition.

- 37

Recording audio (digital sources)

Switch on the REC mode to record a digital input source. Usually use the A-REC (Auto-Record) mode to record audio input sources. When the digital mode changes during recording in the A-REC mode, the audio input source may be interrupted momentarily.

Recording music in A-REC or M-REC mode

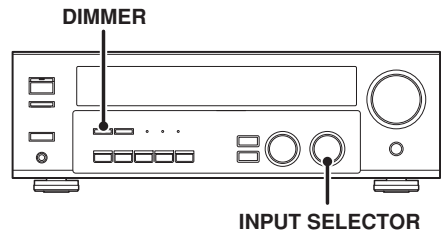

- 1 Use the INPUT SELECTOR knob to select the source (CD/DVD, DVD/6CH or VIDEO2) you want to record.
- 2 Set the MD or TAPE recorder to record.

3 Press and hold the DIMMER key for more than 2 seconds to select the A-REC or M-REC mode during digital input.

- 1 Rec mode off : The digital input record mode is switched off.
- 2 A-REC mode : The digital input signals (DTS, Dolby Digital, or PCM) are identified automatically and converted into stereo signals that are ready for recording.
- 3 M-REC mode : The input signal type at the moment this mode is selected is held throughout this mode.

For A-REC mode:

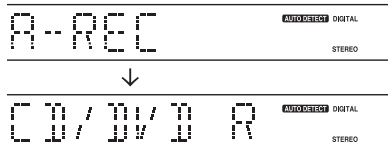

For M-REC mode:

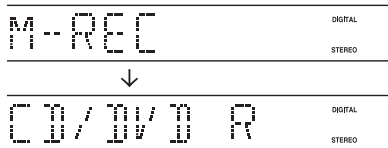

4 Start playback, then start recording.

- If the audio reproduction stops in the middle due to change in the input signals, etc., press the DIMMER key.

Listening to radio broadcasts

The receiver can store up to 40 stations in the memory and recall them by one-touch operation.

Tuning radio stations

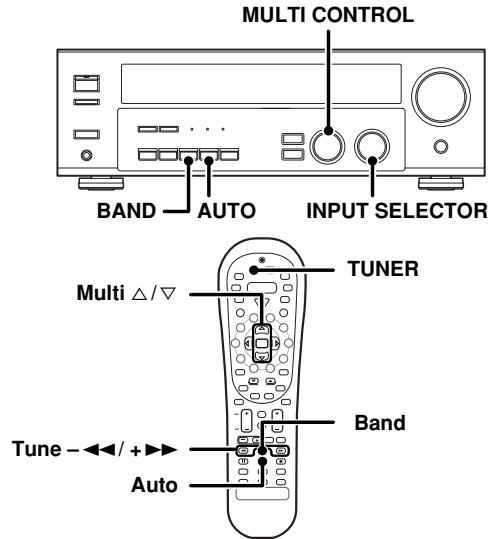

1 Use the INPUT SELECTOR knob or TUNER key to select the tuner.

2 Use the BAND key to select the desired broadcast band.

Each press switches the band as follows:

- 1 FM
- 2 AM

"AM" or "FM" indicator appears in the display

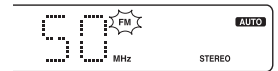

3 Use the AUTO key to select the desired tuning method.

Each press switches the tuning method as follows:

- 1 AUTO lit (auto tuning)
- 2 AUTO not lit (manual tuning)

"AUTO" indicator lights up in the display.

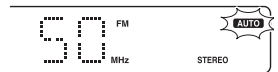

- Normally, set to "AUTO" (auto tuning). If the radio waves are weak and there is a lot of interference, switch to manual tuning. (With manual tuning, stereo broadcasts will be received in monaural.)

4 Use the MULTI CONTROL knob or Multi Δ/∇ keys, or Tune \leftarrow/\rightarrow keys to select the station.

Frequency display

"ST." lights when a broadcast is being received in stereo.

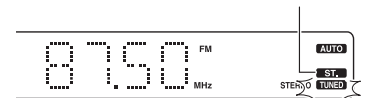

"TUNED" is displayed when a station is received.

Auto tuning : The next station is tuned automatically.

Manual tuning : Turn the knob (press the key) to select the desired station.

Presetting radio stations manually

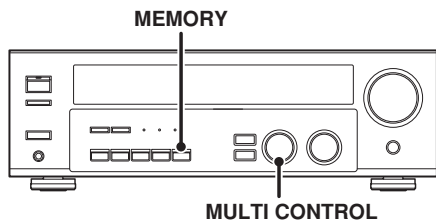

1 Tune to the station you want to store.

2 Press the **MEMORY** key while receiving the station.

Blinks for 5 seconds Lights for 5 seconds

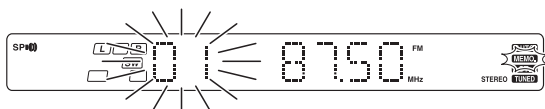

Proceed to step **3** within 5 seconds.
(If more than 5 seconds elapse, press the **MEMORY** key again).

3 Use the **MULTI CONTROL** knob or **Multi** Δ/∇ keys to select one of the station presets (1 – 40).

4 Press the **MEMORY** key again to confirm the setting.

- Repeat steps **1**, **2**, **3**, and **4** to store as many stations as necessary.
- If you store a station at a previously used preset, the previous station will be replaced by the new one.

Receiving preset stations

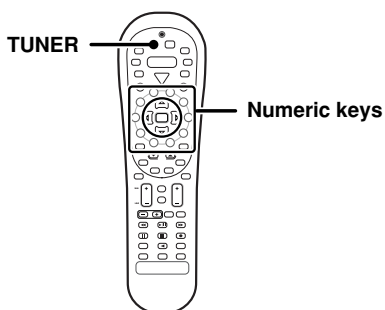

1 Press the **TUNER** key to select tuner as the source.

2 Enter the number of the preset station you want to receive (up to "40").

Press the numeric keys in the following order:

For "15", press $+10$, 5

For "20", press $+10$, $+10$, 0

- If you make a mistake entering a two digit number, press the +10 key repeatedly to return to the original display and start again.



Receiving preset stations in order (P.Call)

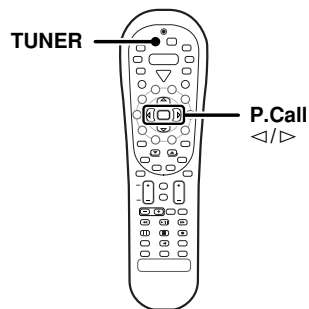

1 Press the **TUNER** key to select tuner as the source.

2 Use the **P.Call** Δ/∇ keys to select the desired station.

- Each time you press the key, another preset station is received in order.

Pressing the **P.Call** \triangleright does the following:

$\rightarrow 01 \rightarrow 02 \rightarrow 03 \rightarrow \dots \rightarrow \dots \rightarrow 38 \rightarrow 39 \rightarrow 40$

Pressing the **P.Call** \triangleleft does the following:

$\leftarrow 01 \leftarrow 02 \leftarrow 03 \leftarrow \dots \leftarrow \dots \leftarrow 38 \leftarrow 39 \leftarrow 40 \leftarrow$

Holding down the **P.Call** \triangleright or \triangleleft key, lets you skip through the presets, receiving each preset station at 0.5 second intervals.

Ambience effects

This receiver is equipped with listening modes that allow you to enjoy an enhanced sonic ambience with a variety of video sources.

In order to obtain the optimum effect from the surround modes, make sure to input the proper speaker settings beforehand.

→ 16

Surround modes

The below speaker placements are for 5.1 channel surround sound system which are;

- Dolby Digital
- Dolby Pro Logic II
- DTS
- DSP
- DVD 6-channel

The below speaker placements are for 6.1 channel surround sound system which is;

- Dolby Digital EX
- Dolby Digital, Dolby Pro Logic II and DSP if "SURR MIX ON".

→ 17

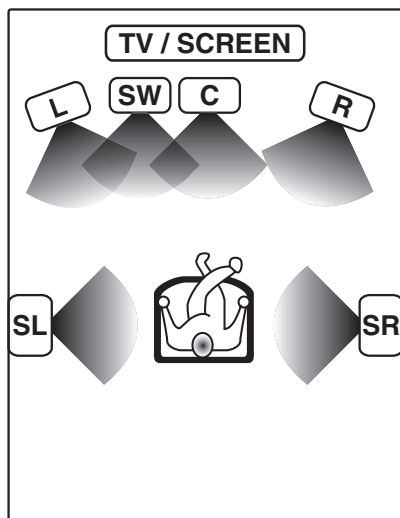

No Surround Back speaker

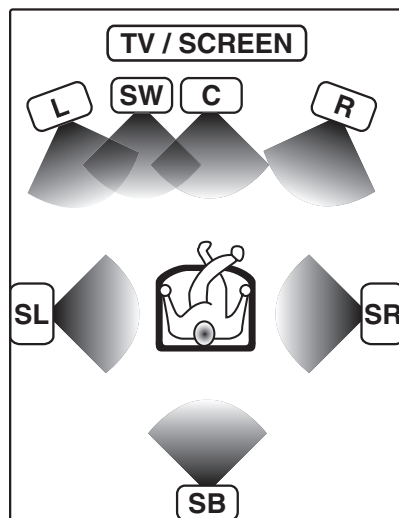

With Surround Back speaker

- L** Front left speaker
- SW** Subwoofer
- C** Center speaker
- R** Front right speaker

- SL** Surround left speaker
- SR** Surround right speaker
- SB** Surround back speaker

Manufactured under license from Dolby Laboratories. "Dolby", "Pro Logic" and the double-D symbol are trademarks of Dolby Laboratories.

Note

LFE = Low Frequency Effects. This channel delivers separate non-directional bass signals to the subwoofer for more dynamic deep bass sound effects.

"DTS" and "DTS Digital Surround" are registered trademarks of Digital Theater Systems, Inc.



Dolby Digital

The Dolby Digital surround format lets you enjoy up to 5.1 channels of digital surround sound from Dolby Digital program sources (such as Laserdisc or DVD software marked ). Compared with previous Dolby surround, Dolby Digital provides even better sound quality, greater spatial accuracy, and improved dynamic range.



Although a full set of speakers (front left, right, and center, surround left and right, and a subwoofer) is required for true 5.1 channel Dolby Digital surround sound, this receiver lets you enjoy Dolby Digital (and Dolby Surround) program sources, even if you connect only the front speakers.

Dolby Digital EX

Dolby Digital EX is an extension of Dolby Digital technology. Dolby Digital EX creates six full-bandwidth output channels from 6.1-channel sources. This is done using a matrix decoder that derives three surround channels from the two in the original recording. This is achieved by using three different surround signals, surround left, surround right, and surround back, each driving its own array of speakers. Think of it as adding a center channel for the rear speakers, which give more diffuse and natural surround effect, even if you wanted the ability to completely encircle the audience with sound, positioning sound effects exactly where they would be heard in real life. For best results, Dolby Digital EX should be used with movie soundtracks recorded with Dolby Digital Surround EX which contain a digital flag that will automatically activate this feature. However, for titles released prior to late 2001, this feature has to be activated manually.

Although a full set of speakers (front left, right, and center, surround left and right, surround back and a subwoofer) is required for true 6.1 channel Dolby Digital Surround EX sound, this receiver lets you enjoy Dolby Digital (and Dolby Surround) program sources, even if you connect only the front speakers.

Although only Dolby Digital soundtracks incorporate a separate low frequency channel, connecting a subwoofer will also improve deep bass performance in the other surround modes.



The indication "**LFE**" appears in the display when a signal is being input for this channel.  

Dolby PRO LOGIC II

Dolby Pro Logic II was designed specifically to provide a new sense of spatiality, directionality and articulation of sounds from Dolby Surround encoded sources (such as video and Laserdisc software marked ). This is achieved with an intelligent, built-in feedback logic design, a matrix surround decoding and the decoding of stereo, full bandwidth surround outputs. The PRO LOGIC II modes programmed into this receiver are "MOVIE", "MUSIC" and "PRO LOGIC". The "MOVIE" mode of the PRO LOGIC II has preset characteristics to produce a calibrated, high-level surround sound playback while the "MUSIC" mode has user-adjustable characteristics to offer the three optional different controls, like "Dimension", "Center Width" and "Panorama" modes to allow optimization of the soundfields as desired. The "Dimension" control allows the user to gradually adjust the soundfield either towards the front or towards the rear; the "Center Width" control allows various adjustment of the left-center-right speakers' balance; the "Panorama" mode extends the front stereo image to include the surround speakers for an exciting "wraparound" effect with side wall imaging.

DTS mode

The DTS multi-channel audio format is available on CD, LD and DVD software. DTS is a strictly digital format and cannot be decoded inside most CD, LD or DVD players. For this reason, if you attempt to listen to DTS encoded software through the analog output of your new CD, LD or DVD player, you will experience digital noise in most cases. This noise can be quite loud if the analog output is connected directly to a high power amplification system. Proper measures for playing the digital output as described below should be taken to avoid this situation. To enjoy DTS Digital Surround playback, an external 5.1 channel DTS Digital Surround decoder system or an amplifier with a built-in DTS Digital Surround decoder must be connected to the digital output (S/P DIF, AES/EBU or TosLink) of a CD, LD or DVD player. All models are incorporated with the DTS decoder.

DTS has a .1 or **LFE** channel. The indication "**LFE**" appears in the display when a signal is being input for this channel.  

DSP mode



The DSP mode lets you add the atmosphere of a live concert or hall to almost any type of program source. These modes are particularly effective when used with stereo program sources, like CD, television, and FM radio. You might enjoy trying the ARENA, JAZZ CLUB, THEATER, STADIUM or DISCO mode the next time you watch a concert or sporting event!

What's DSP?



DSP stands for Digital Signal Processor. The way a sound is heard in an actual environment depends on a variety of different factors. One of the most important is reverberation (the act of decaying elements of sound echoing in various places). The DSP modes produce the feeling of presence by using the DSP to create reverberation, without spoiling the sound quality of the original signal.

DVD 6-channel mode

Using a DVD player or the like equipped with six (5.1) output channels and the receiver, you can enjoy multi-channel encoded DVD source material in all its splendor. Since the source signals are digital and each channel is input independently, the resulting sound quality, sense of spaciousness, and dynamic range are superb.

The indication "**LFE**" appears in the display during DVD 6-channel mode selection.  

Surround play

The DTS compatible models can reproduce a CD, DVD, or LD carrying the DTS mark. DOLBY DIGITAL can be used when playing DVD or LD software bearing the  mark and DOLBY DIGITAL format digital broadcasts (etc.). DOLBY PRO LOGIC can be used when playing video, DVD, or LD software bearing the  mark.

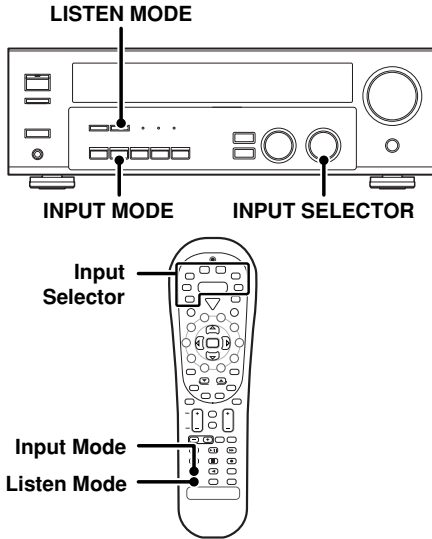

Preparations

- Turn ON related components.
- Complete "Preparing for surround sound" (speaker settings). → [16]
- Use the **INPUT SELECTOR** to select the component you wish to play back with surround sound.
- Use the **INPUT MODE** key to select the input mode (analog or digital) for the source you wish to playback. → [8]
- Noise will be produced when a DTS source is played by selecting the analog input.

1 Start playing the video software.

2 Press the LISTEN MODE key to select the listening mode.

The listening mode settings are stored separately for each input. If the input mode is set to full auto ("AUTO DETECT" lights), the receiver selects the optimal listening mode automatically based on the type of input signal and the speaker settings.

Each press of the LISTEN MODE key switches the setting as listed.

The listening mode settings are different depending on the type of input signal.

When the DOLBY DIGITAL or DOLBY DIGITAL EX signal is input:

(The DOLBY DIGITAL or PRO LOGIC indicator lights up.)

- 1 **DOLBY DIGITAL** : DOLBY DIGITAL surround.
- 2 **DOLBY DIGITAL EX** : DOLBY DIGITAL EX surround.
(The DOLBY DIGITAL EX LED indicator lights up.)
- 3 **PL II MOVIE** : PRO LOGIC II surround MOVIE mode.
(The PRO LOGIC indicator lights up.)
- 4 **PL II MUSIC** : PRO LOGIC II surround MUSIC mode.
(The PRO LOGIC indicator lights up.)
- 5 **PRO LOGIC** : PRO LOGIC II surround PRO LOGIC mode.
(The PRO LOGIC indicator lights up.)
- 6 **STEREO** : Normal stereo playback.
(The STEREO indicator lights up.)

When you select DOLBY DIGITAL

"DOLBY DIGITAL" will scroll from right to left.

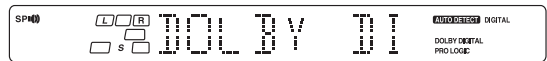

When the DTS signal is input:

(The DTS LED indicator lights up.)

- 1 **DTS** : DTS surround
- 2 **STEREO** : Normal stereo playback

When the analog signal or the digital signal (except for DOLBY DIGITAL or DTS signal) is input:

- 1 **PL II MOVIE** : PRO LOGIC II surround MOVIE mode.
(The PRO LOGIC indicator lights up.)
- 2 **PL II MUSIC** : PRO LOGIC II surround MUSIC mode.
(The PRO LOGIC indicator lights up.)
- 3 **PRO LOGIC** : PRO LOGIC II surround PRO LOGIC mode.
(The PRO LOGIC indicator lights up.)
- 4 **ARENA** : DSP Surround ARENA mode.
- 5 **JAZZ CLUB** : DSP Surround JAZZ CLUB mode.
- 6 **THEATER** : DSP Surround THEATER mode.
- 7 **STADIUM** : DSP Surround STADIUM mode.
- 8 **DISCO** : DSP Surround DISCO mode.
- 9 **STEREO** : Normal stereo playback.
(The STEREO indicator lights up.)

- Dolby Digital or DTS signal having more channels than the maximum number of playback channels available using the receiver's current settings is input, downmixing is performed to match the number of available channels.

3 Adjust the volume.

Notes

- Depending on the type of the signal or speaker setting, some listening modes cannot be selected.
- When playback is started, the sound may be cut or interrupted before the input source is confirmed as Dolby Digital.
- To enjoy Dolby Digital surround (as well as all the other listening modes) from a single component, be sure to use a Dolby Digital compatible source component.

DVD 6-channel playback

Using a DVD player or the like equipped with six (5.1) output channels and the receiver, you can enjoy surround sound playback. Connecting a DVD player which can decode the surround signal itself is also acceptable.

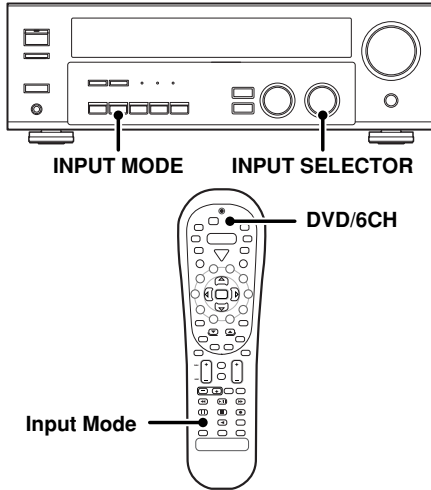

Preparations

- Connect your DVD player to the DVD/6CH jacks of the receiver.
- Turn on all other components that will be used.
- Complete "Preparing for surround sound".



- 1 Select "DVD/6CH" as the input source.
- 2 Select "6CH INPT" by pressing the INPUT MODE key.
- 3 Start playback of the DVD software.
- 4 Adjust the volume.

• It is not possible to adjust the volume level or sound quality (**SETUP, SOUND, LISTEN MODE, ACTIVE EQ and Tone keys will not be functional**) of the channels separately when the receiver is in the 6CH INPUT mode. Adjust the volume with the controls of the DVD player. For the powered subwoofer, you can adjust the volume of the subwoofer using the subwoofer's own volume control.

Convenient functions

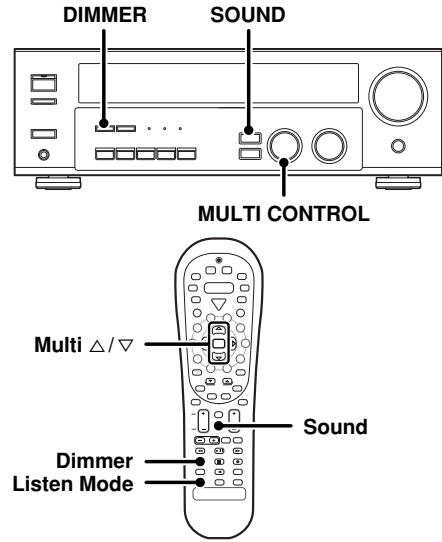

Adjusting the sound

You can make further adjustments to the sound while listening to playback in the surround mode.

- 1 For the remote control, press and hold the TUNER key for more than 3 seconds to switch to receiver mode.
- 2 Press the SOUND key until the desired item appears in the display.

Each time you press the button, the menu changes as follows: Note that some items are not displayed in certain modes.

- 1 C (center speaker level adjustment)*
- 2 SR (right surround speaker level adjustment)*
- 3 SB (surround back speaker level adjustment)*
- 4 SL (left surround speaker level adjustment)*
- 5 SW (subwoofer level adjustment)*
- 6 INPUT (input level adjustment - analog mode only)
- 7 NIGHT (midnight mode ON/OFF - Dolby Digital mode only)
- 8 PANORAMA (panorama mode ON/OFF)**
- 9 DIMENSION (dimension adjustment)**
- 10 CENTER WIDTH (center width adjustment)**

* The adjustment is only temporary for the current input selection. The value will return automatically to the original setup value when the power is turned on/off or when the input selection is changed.

** Pro Logic II Music mode only.

- 3 Use the MULTI CONTROL knob or Multi Δ/∇ keys to adjust the setting as desired.

Midnight mode (Dolby Digital mode only)

When watching movies at night, you might not be able to raise the volume as loud as normal. Midnight mode compresses the dynamic range of previously specified heavy sound passage of the Dolby Digital sound track (like scenes with sudden increases in volume) to minimize the difference in volume between the scenes with heavy sound passage and scenes with normal sound passage. This makes it easy to hear all of the sound track, even when listening at low volumes.

- 1 Press the SOUND key repeatedly until "NIGHT" appears on the display.
 - This can be selected only if CD/DVD, DVD/6CH or VIDEO2 is selected as the source and the listen mode is set to "DOLBY DIGITAL."

Ambience effects

- ② Use the **MULTI CONTROL knob** or **Multi Δ/∇ keys** to select the **ON** or **OFF** setting.



- Some Dolby Digital software may not be compatible with the Midnight mode.

Panorama mode (Pro Logic II Music mode only)

When listening to music, you will be able to enjoy the “wraparound” sound effect when you adjust the panorama mode.

- ① Press the **SOUND key** repeatedly until “PANORAMA” appears on the display.

- The PANORAMA setting indication scrolls across the display.

“PANORAMA” will be scrolled from right to left.



- ② Use the **MULTI CONTROL knob** or **Multi Δ/∇ keys** to select **PANORAMA ON** or **OFF**.

- ① **ON** : PANORAMA mode is ON.
- ② **OFF** : PANORAMA mode is OFF.



Dimension mode (Pro Logic II Music mode only)

When listening to music with certain recordings, you will also be able to achieve a suitable balance from all the speakers by adjusting the dimension mode.

- ① Press the **SOUND key** repeatedly until “DIMENSION” appears on the display.

- The DIMENSION indication scrolls across the display.

- ② Use the **MULTI CONTROL knob** or **Multi Δ/∇ keys** to adjust the soundfield towards the rear or the front.

Soundfield is adjusted towards the front.



Soundfield is in neutral position.

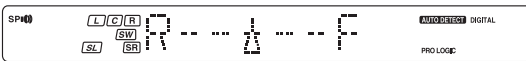

Soundfield is adjusted towards the rear.

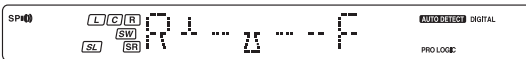

Center Width mode (Pro Logic II Music mode only)

Center Width adjustment allows you to enjoy an enhanced sound when listening to music through center image from only center speaker, or left and right speakers or various combinations adjustments.

- ① Press the **SOUND key** repeatedly until “CENTER WIDTH” appears on the display.

- The CENTER WIDTH indication scrolls across the display.
- When the center speaker is switched OFF, this mode will not be effective.

- ② Use the **MULTI CONTROL knob** or **Multi Δ/∇ keys** to adjust the left-center-right output.

Center image will be heard from center speaker only.



Center image will be heard from left and right speakers only.



- When in other positions, center image from center speaker, left and right speakers can be heard simultaneously with various combinations.

Display dimmer adjustment

The dimmer function lets you select the brightness of the receiver's display. You might find this useful if you darken your room to watch movies or listen to music.

Each time you press the DIMMER key, the display brightness changes among the three available settings. Select the brightness level you find most pleasing.

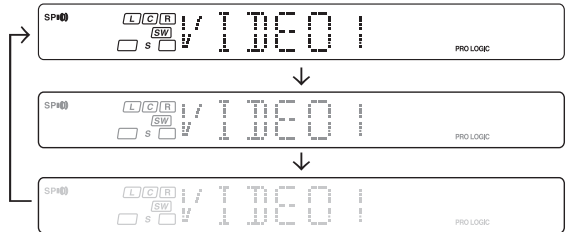

96kHz LPCM playback

The receiver is compatible with the 96kHz LPCM playback. To play a 96kHz DVD, set the listen mode to “STEREO”.

- In **F-AUTO** input mode, the listen mode will automatically be STEREO.
- When in **D-MANUAL** input mode (listen mode is not STEREO), “FS 96kHz” will appear in the display and no sound can be heard from the speakers. Press the **LISTEN MODE key** (the listen mode changes to the STEREO mode) to output sound from the speakers.

Basic remote control operations for other components

The remote control supplied with this receiver is also capable of controlling components from a variety of manufacturers once you register the appropriate setup codes into the remote control unit.

Low battery warning

Replace all two batteries with new ones when you notice a shortening of the distance from which the remote control will operate. The remote control is designed to retain setup codes in memory while you change batteries.

Registering setup codes for other components

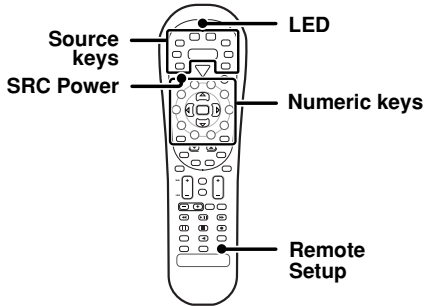

1 Find the setup code of the component to be registered.

- Refer to the setup code lists to find the setup code for the component to be registered. - 30
Example: To register a DVD made by KENWOOD, you would enter "0534".

Input	Component	Maker	Code	Key
(DVD)	DVD player	KENWOOD	0534	DVD/6CH

Source key	Other components
TUNER	Receiver (Kenwood)
DVD/6CH	DVD (other manufacturers')
CD/DVD	CD and MD (Kenwood)
MD/TAPE	Cassette deck (Kenwood)
VID1/ AUX	VCR and PVR (other manufacturers')
VID2	Cable and DTV decoder (other manufacturers')
TV	TV/VCR combo, TV/DVD combo, TV (other manufacturers')

2 Press the Source (AUX, VID2, VID1, DVD/6CH, CD/DVD, MD/TAPE) keys.

- While in Tuner mode, setup code function will not be available.

3 Press and hold the Remote Setup key until the LED blinks twice, then release the Remote Setup key.

4 Press the numeric key to enter the four-digit code for the component to be registered.

- If performed correctly, the LED will blink twice.
- Point the remote control at the component and press SRC (source) Power key once. It should turn on or off. If it does not respond repeat steps 2 to 4.
- If the component still does not work, try searching for the code.

5 Repeat steps 2 to 4 to register additional components until all components have been registered.

Note

Although each setup code is designed to work with a number of different models, certain codes may not work with some models. (Also, certain codes may only operate some of the functions available on a given model.)

Searching for your code

If your component does not respond after trying all the codes listed for your component, or if your component is not listed at all, try searching for your code.

For example, to search for a code for your TV.

1 Press the TV key once. Next, press and hold the Remote Setup key until the LED blinks twice, then release the Remote Setup key.

2 Press the numeric key to enter "9 - 9 - 1".

- The LED will blink twice.

3 Point the remote control at the TV and slowly alternate between pressing the SRC (source) Power and TV keys.

- Stop when the TV turns on or off.
- In the search mode, the remote control will send IR codes from its library to the selected device, starting with the most popular code first.

4 Press the Remote Setup key once to lock in the code.

5 To search for the codes of your other components, repeat steps 1 through 4, but substitute the appropriate key (i.e., AUX, VID2, VID1, DVD/6CH, CD/DVD, MD/TAPE) for the component you are searching for.

Checking the codes

If you have set up the remote control using the procedures described in "Searching for your codes", you may need to find out which four-digit code is operating your equipment:

For example, to find out which code is operating your TV:

1 Press the TV key once. Next, press and hold the Remote Setup key until the LED blinks twice, then release the Remote Setup key.

2 Press the numeric key to enter "9 - 9 - 0".

- The LED will blink twice.

3 To view the code for the first digit, press "1" once. Wait for 3 seconds, count the number of times the LED blinks (e.g., blinks = 3) and write down that number.

- If a code digit is "0", the LED will not blink.

4 Repeat step 3 three more times for the remaining digit. Use "2" for the second digit, "3" for the third digit, and "4" for the fourth digit.

5 To check the codes of your other components, repeat steps 1 through 4, but substitute the appropriate key (i.e., AUX, VID2, VID1, DVD/6CH, CD/DVD, MD/TAPE) for the component you are checking.

- As suggested earlier on, write down each of the four-digit code.

Re-assigning device keys

The remote control can be set up to control a second TV or VCR, or any combination of eight home entertainment components.

For example, to control the operation of two different VCR using the remote control, the user need to re-assign the unused VID2 key to operate the second VCR (VID1) as follows:

1 Press and hold the Remote Setup key until the LED blinks twice, then release the Remote Setup key.

2 Press the numeric key to enter "9 - 9 - 2".

- The LED will blink twice.

3 Press the VID1 key once, then press the VID2 key once.

- The user now can operate VID2 as a second VCR along with VID1.
- Refer to the table in the previous page for the combination of source keys and the other components assignment. → [28]

4 To re-assign other device keys, repeat steps 1 through 3 by substituting the key sequence from the chart below for the most popular components:

To re-assign key

Sequence	Perform
TV as 2nd VID1 key	Remote Setup -9 -9 -2 -VID1 - TV
TV as 2nd VID2 key	Remote Setup -9 -9 -2 -VID2 - TV
TV as 2nd CD/DVD key	Remote Setup -9 -9 -2 -CD/DVD - TV
TV back to TV key	Remote Setup -9 -9 -2 -TV - TV
VID1 as 2nd TV key	Remote Setup -9 -9 -2 -TV - VID1
VID1 as 2nd VID2 key	Remote Setup -9 -9 -2 -VID2 - VID1
VID1 as 2nd CD/DVD key	Remote Setup -9 -9 -2 -CD/DVD - VID1
VID1 back to VID1 key	Remote Setup -9 -9 -2 -VID1 - VID1

5 To clear the re-assignment and reset the remote control to its original operation mode:

1 Press and hold the Remote Setup key until the LED blinks twice, then release the Remote Setup key.

2 Press the numeric key to enter "9 - 9 - 2".

3 Press the VID2 key twice.

- When a re-assignment is done, the LED will blink twice to confirm your choice. At that time, you will need to program the remote control in order to control the new component.
- If an invalid key sequence is entered, the LED blink once and return to normal operation.
- When in Tuner mode, re-assignment is not available.

Operating other components

This operation lets you operate the registered components. KENWOOD audio components with system control turn on and off automatically with the receiver via the system control connections.

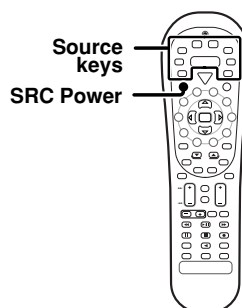

1 Use the Source keys to select the component you desire.

- Pressing the Source keys also changes the input selector on the receiver. → [7]

• **When you operate your registered DVD player, CD player, Cassette deck, MD player, Cable, DTV decoders, VCR or TV, go to step 2.**

• **When you operate the CD player, Cassette deck, MD player, or Tuner with system control connection, go to step 2.**

2 Press the SRC (source) Power key.

- To return to the receiver operation mode, press the **TUNER** key for more than 3 seconds.

3 Press the operation keys you desire. → [34]

The remote control mode remains at the selected input. If you wish to operate another component, repeat step 2 or 3.

Note

- Be sure to point the remote control at the remote sensor on the receiver when you want to operate KENWOOD components connected by system control cords. Otherwise, point the remote control at the component you want to operate.
- To initialize the remote control, press the Remote Setup key until the LED blinks twice. Then press the numeric key to enter "9-8-1". The LED blinks twice.

Setup code chart

TV Setup codes

Manufacturer	Setup Codes
AOC	0019, 0030
Admiral	0093, 0463
Adventura	0800
Aiko	0092
Aiwa	0701, 0800, 0802
Akai	0030
Alaron	0179
America Action	0180
Ampro	0751
Anam	0180
Apex Digital	0748, 0765, 0767
Asha	0804
Audiovox	0092, 0180, 0451, 0623, 0802
Baysonic	0180
Belcor	0019
Bell & Howell	0016, 0154
Beaumarck	0804
Bradford	0180
Brockwood	0019
Broksonic	0236, 0463, 0817, 0901
CXC	0180
Calix	0802
Candle	0030, 0056
Carnivale	0030
Carver	0054
Celebrity	0000
Changhong	0765
Cineral	0092, 0451
Citizen	0030, 0056, 0060, 0092, 0802, 0816
Concerto	0056
Contec	0180
Craig	0180, 0802, 0804
Crosley	0054
Crown	0180
Curtis Mathes	0016, 0030, 0047, 0054, 0056, 0060, 0093, 0145, 0154, 0166, 0451, 0466, 0747, 0809, 1147, 1347
Cybernex	0804
Daewoo	0019, 0092, 0451, 0623, 0816
Daytron	0019
Denon	0145
Dumont	0017, 0019
Dynatech	0800
Dwin	0720, 0774
Electroband	0000
Electrohome	0802
Electroponic	0802
Emerson	0019, 0154, 0178, 0179, 0180, 0236, 0463, 0623, 0800, 0802, 0816, 0817
Envision	0030
Fisher	0154
Fujitsu	0179, 0683
Funai	0171, 0179, 0180, 0800
Futuretech	0180
Garrard	0800

Manufacturer	Setup Codes
GE	0021, 0047, 0051, 0178, 0251, 0451, 0747, 0804, 0807, 0809, 0811, 1147, 1347
Gibraltar	0017, 0019, 0030
GoldStar	0019, 0030, 0178, 0802, 0814
Gradiente	0053, 0056, 0800
Grunpy	0179, 0180
Hallmark	0178
Harley Davidson	0179, 0800
Harman/Kardon	0054
Harvard	0180
Havermy	0093
Hitachi	0016, 0056, 0145, 0800
Infinity	0054
Inteq	0017
JBL	0054
JCB	0000
JVC	0053
KEC	0180, 0802
KTV	0030, 0180
Kenwood	0019, 0030
Kodak	0802
Konka	0632, 0628, 0638, 0703, 0707
LG	0056
LXI	0047, 0054, 0154, 0156, 0178, 0747, 0802
Logik	0016
Luxman	0056
Lloyd's	0800
MGA	0019, 0030, 0150, 0178, 0804
MTC	0019, 0030, 0056, 0060, 0800, 0804
Magnavox	0030, 0054, 0179, 0800, 0818, 1254, 1454
Magnasonic	0816
Magnin	0804
Majestic	0016
Marantz	0030, 0054
Marta	0802
Matsushita	0250
Megatron	0145, 0178
Memorex	0016, 0150, 0154, 0178, 0179, 0250, 0463, 0800, 0802, 0804, 0810, 0812, 0814, 0815
MGN Technology	0804
Midland	0017, 0047, 0051, 0747
Minutz	0021
Mitsubishi	0019, 0093, 0150, 0178, 0807
Motorola	0093
Multitech	0180, 0800
NAD	0156, 0166, 0178
NEC	0019, 0030, 0056, 0497
NTC	0092
Nikko	0030, 0092, 0178, 0802
Noblex	0804
Onwa	0180
Optimus	0154, 0166, 0250, 0802, 0812, 0815
Optonica	0093

Setup code chart

Manufacturer	Setup Codes
Orion	0179, 0236, 0463, 0817
Panasonic	0051, 0250, 0809, 0812, 0815, 0907, 0908
Penney	0019, 0021, 0030, 0047, 0051, 0060, 0156, 0178, 0747, 0802, 0804, 0809, 0814, 1347
Philco	0019, 0030, 0054, 0145, 0463
Philips	0054, 0904, 1454
Pilot	0019, 0030, 0802
Pioneer	0166, 0679
Portland	0019, 0092
Princeton	0717
Prism	0051
Proscan	0047, 0747, 0811
Profitronic	0804
Proton	0178, 0466
Pulsar	0017, 0019
Quasar	0051, 0250, 0809, 0812
RCA	0019, 0047, 0090, 0679, 0747, 0804, 0807, 0809, 0811, 0905, 1047, 1147, 1247, 1347, 1447, 1547
RadioShack	0019, 0030, 0047, 0056, 0154, 0178, 0180, 0747, 0800, 0810
Radix	0802
Randex	0802
Realistic	0019, 0030, 0056, 0154, 0178, 0180, 0800, 0802
Runco	0017, 0030, 0251, 0497, 0603
SSS	0019, 0180
Sampo	0030
Samsung	0019, 0030, 0056, 0060, 0178, 0766, 0804
Sansei	0451
Sansui	0463, 0800, 0817, 0901
Sanyo	0154, 0804
Scimitsu	0019
Scotch	0178
Scott	0019, 0178, 0179, 0180, 0236
Sears	0047, 0054, 0056, 0154, 0156, 0171, 0178, 0179, 0747, 0800, 0802, 0814
Semivox	0180
Semp	0156
Sharp	0093, 0688, 0689, 0807, 0900
Shogun	0019, 0804
Signature	0016
Sony	0000, 0800, 0813
Soundesign	0178, 0179, 0180
Squareview	0171
Starlite	0180
Supreme	0000
Sylvania	0030, 0054, 0171, 0800, 0818, 0903
Symphonic	0171, 0180, 0800
TMK	0056, 0178, 0804
TNCi	0017
Tandy	0093
Teac	0800
Technics	0051, 0250
Technol Ace	0179

Manufacturer	Setup Codes
Techwood	0051, 0056
Teknika	0016, 0019, 0054, 0056, 0060, 0092, 0150, 0179, 0180, 0800, 0802
Telefunken	0056
Thomas	0800
Toshiba	0060, 0154, 0156, 0901, 0906, 1256
Totevision	0802, 0804
Unitech	0804
Vector Research	0030
Victor	0053
Videomagic	0802
Vidikron	0054, 0242
Vidtech	0019, 0178
Videosonic	0804
Villian	0800
Wards	0016, 0019, 0021, 0030, 0054, 0056, 0178, 0179, 0800, 0804
Waycon	0156
White Westinghouse	0463, 0623, 0816
XR-1000	0800
Yamaha	0019, 0030, 0769
Zenith	0016, 0017, 0092, 0463, 0800, 0817

Cable Setup codes

Manufacturer	Setup Codes
ABC	0003, 0008, 0014, 0017
Americast	0899
Bell & Howell	0014
Bell South	0899
Director	0476
General Instrument	0003, 0276, 0476, 0810
GoldStar	0144
Hamlin	0009, 0273
Jerrold	0003, 0012, 0014, 0276, 0476, 0810
Memorex	0000
Motorola	0276, 0476, 0810, 1106
Pace	0237
Panasonic	0000, 0107
Paragon	0000
Philips	0305, 0317
Pioneer	0144, 0533, 0877, 1877
Pulsar	0000
Quasar	0000
Regal	0273, 0279
Runco	0000
Samsung	0144
Scientific Atlanta	0008, 0017, 0477, 0877, 1877
Sony	1006
Starcom	0003
Supercable	0276
Tocom	0012
Torx	0003
Toshiba	0000
Zenith	0000, 0525, 0899

Setup code chart

DVD player Setup codes

Manufacturer	Setup Codes
Aiwa	0641
Apex Digital	0672, 0717, 0755, 0794, 0795, 0796, 0797, 0830
Blue Parade	0571
DVD2000	0521
Daewoo	0784
Denon	0490, 0634
Emerson	0591
Enterprise	0591
Fisher	0670
GE	0522, 0717, 0815
GPX	0769
Go Video	0715
Gradiente	0651
Greenhill	0717
Harman/Kardon	0582, 0702
Hitachi	0573, 0664
Hiteker	0672
JBL	0702
JVC	0558, 0623
KLH	0717
Kenwood	0490, 0534, 0682
Konka	0711
Koss	0651
Magnavox	0503, 0675
Marantz	0539
Microsoft	0522
Mintek	0717
Mitsubishi	0521
Nesa	0717
Onkyo	0503
Oritron	0651
Panasonic	0490, 1490
Philips	0503, 0539, 0646
Pioneer	0525, 0571
Polk Audio	0539
Proscan	0522
RCA	0522, 0571, 0717
Rowa	0823
Sampo	0698
Samsung	0573
Sanyo	0670
Shinsonic	0533
Sony	0533
Sylvania	0675
Technics	0490
Theta Digital	0571
Toshiba	0503
Urban Concepts	0503
Yamaha	0490, 0539, 0545
Zenith	0503, 0591

VCR Setup codes

Manufacturer	Setup Codes
Admiral	0048, 0209
American High	0035
Bell & Howell	0104
Broksonic	0121, 0184, 0209
Canon	0035
Carver	0081
Craig	0047
Curtis Mathes	0035, 0060, 0162, 0760
Daewoo	0045
Denon	0042
Emerex	0032
Emerson	0043, 0121, 0184, 0209
Fisher	0047, 0104
Fuji	0033, 0035
GE	0035, 0060, 0760
HI-Q	0047
Harman/Kardon	0081
Hitachi	0042
Hughes Network Systems	0042
JVC	0067
Kenwood	0067
Kodak	0035
MEI	0035
MGA	0043
Magnavox	0035, 0039, 0081, 0563
Marantz	0035, 0081
Matsushita	0035, 0162
Memorex	0035, 0039, 0047, 0048, 0104, 0162, 0209
Minolta	0042
Mitsubishi	0043, 0067
Motorola	0035, 0048
NEC	0067, 0104
Olympus	0035
Optimus	0048, 0104, 0162, 1048, 1062
Orion	0184, 0209
Panasonic	0035, 0162, 0225, 0616, 1062
Penney	0035, 0042
Pentax	0042
Philco	0035, 0209
Philips	0035, 0081, 0618, 1081, 1181
Pioneer	0067
Polk Audio	0081
Proscan	0060, 0760
Pulsar	0039
Quasar	0035, 0162
RCA	0042, 0060, 0760
Realistic	0035, 0047, 0048, 0104
ReplayTV	0614, 0616
Runco	0039
STS	0042
Samsung	0045
Sanky	0039, 0048
Sansui	0067, 0209

Setup code chart

Manufacturer	Setup Codes
Sanyo	0047, 0104
Scott	0043, 0045, 0121, 0184
Sears	0035, 0042, 0047, 0104
Semp	0045
Sharp	0048
Sonic Blue	0614, 0616
Sony	0032, 0033, 0035, 0636, 1032
Sylvania	0035, 0043, 0081
Technics	0035, 0162
Teknika	0035
Tivo	0618, 0636
Toshiba	0043, 0045
Vector	0045
Video Concepts	0045
Wards	0035, 0042, 0047, 0048, 0060, 0081, 0760
White Westinghouse	0209
XR-1000	0035
Zenith	0033, 0039, 0209

Setup codes for Kenwood components with System Control connection

Component	Setup Codes
CD	1338
MD	1339
Cassette deck	1340

Cassette deck Setup codes

Manufacturer	Setup Codes
Kenwood	0070, 0071, 0092, 0183, 0205, 0233, 0234, 0251, 0386

Receiver Setup codes

Manufacturer	Setup Codes
Kenwood	1570

CD and MD players Setup codes

Manufacturer	Setup Codes
Kenwood	0028, 0037, 0190, 0338, 0339, 0340, 0523, 0626, 0677, 0681, 0826, 0858, 0859, 1490

DTV decoders Setup codes

Manufacturer	Setup Codes
Panasonic	1120
Pioneer	1010
Princeton	0113, 0295
Samsung	1190
Sensory Science	1126
Sharp	1010

CASSETTE deck, CD player & MD recorder operations

You can perform these basic operations using the keys described below when connected to KENWOOD cassette deck, CD player or MD recorder equipped with system control operations. - 15

Cassette deck operations' keys

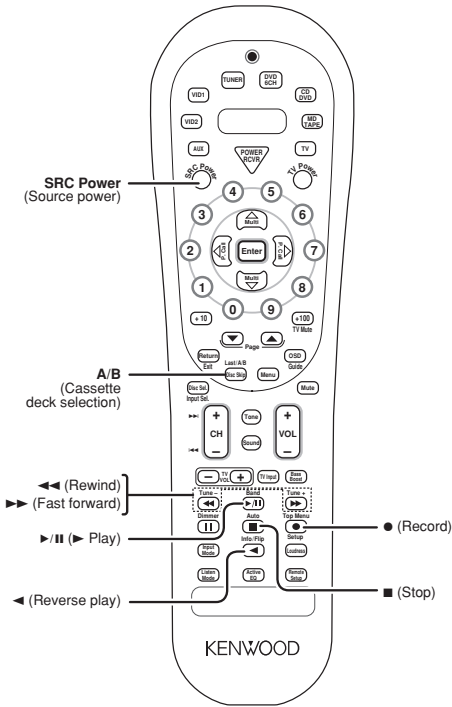

CD player operations' keys

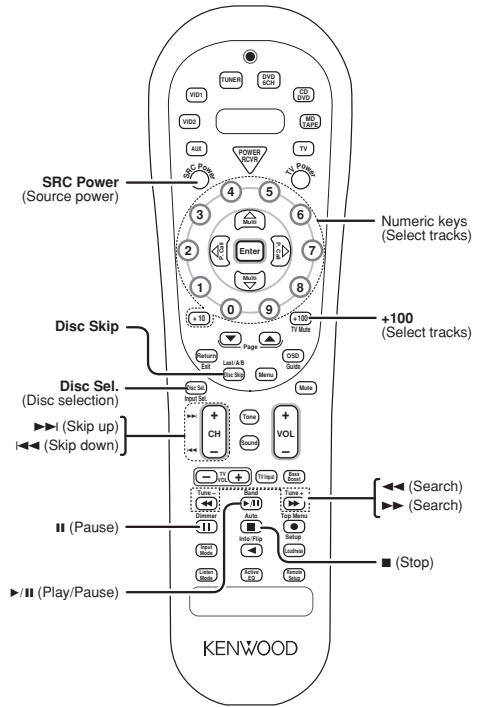

MD recorder operations' keys

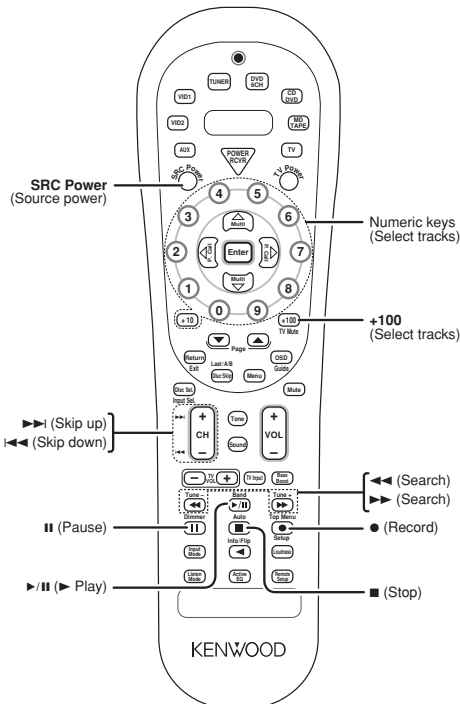

Other components' operations

Refer to the following for the type of remote control operations available for each component.

- ❶ Select the input source.
- ❷ Press the keys corresponding to the operations you desire. Refer to the following sections for details.

- When pressing keys in succession, press each key firmly and be sure to wait at least 1 second before pressing the next key.
- Numeric keys function the same as the numeric keys on the original remote.

These keys can be used to perform the basic operations of KENWOOD and other manufacturers' components which the setup code for each component had been entered beforehand. - 30

TV operation keys

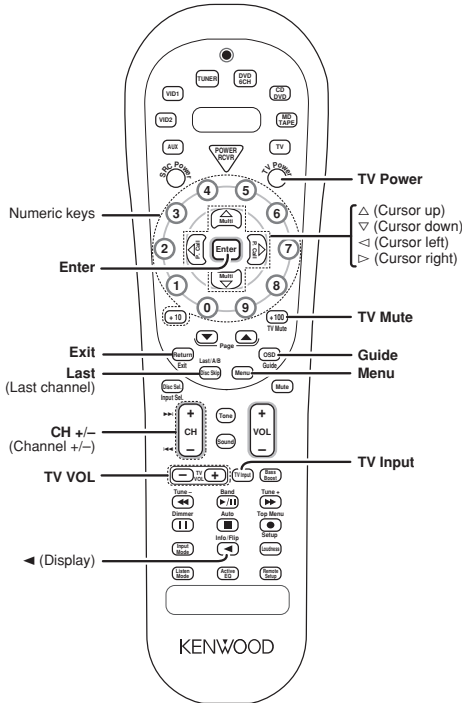

VCR operation keys

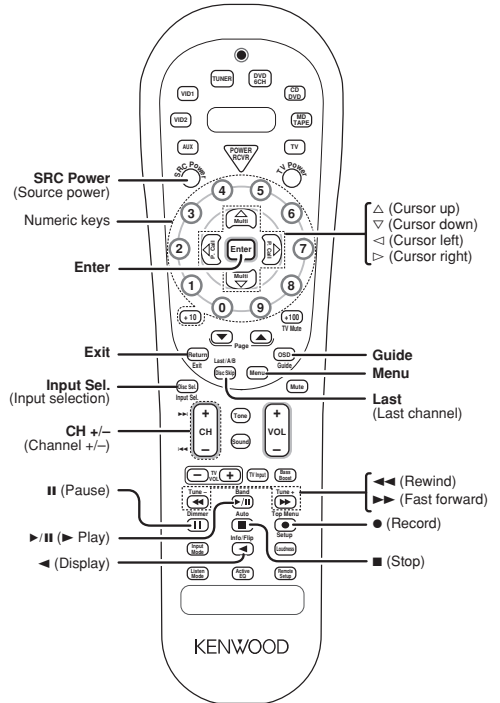

DVD player operation keys

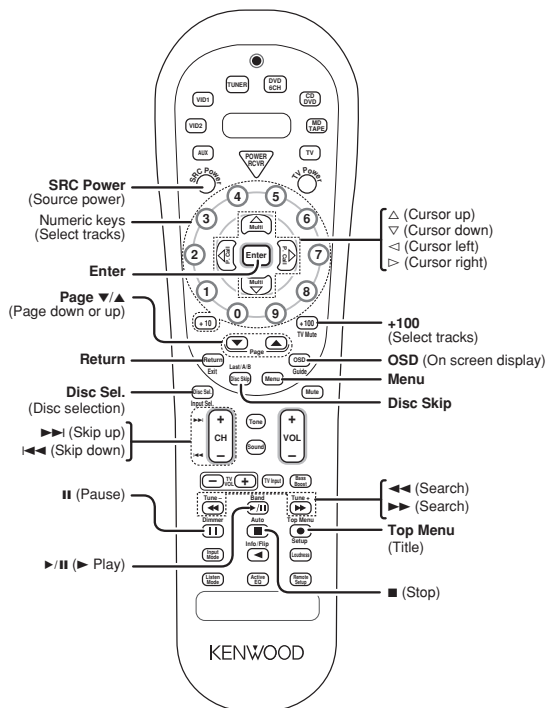

Cable operation keys

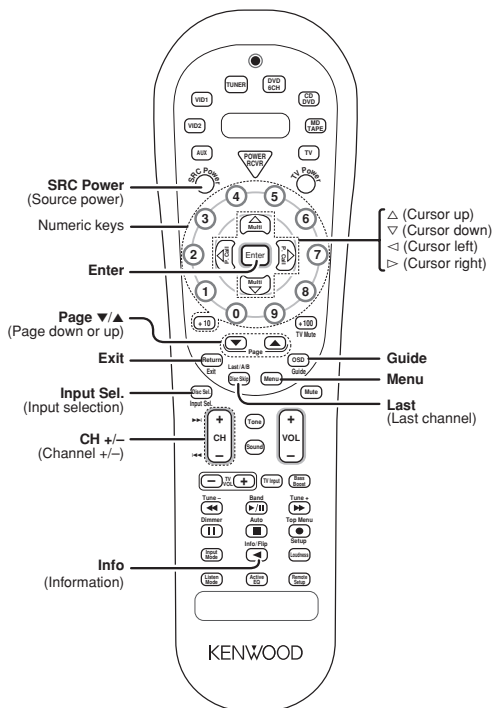

Notes

1. Certain codes may only operate some of the function available on a given model.
2. The above show the typical functions available for each component. Some manufacturers use different key combinations to perform similar functions. For that reason, we have programmed extra functions on some of the unused number keys to help you control your equipment.

In case of difficulty

Resetting the Microcomputer

The microcomputer may malfunction (unit cannot be operated, or shows an erroneous display) if the power cord is unplugged while the power is ON, or due to some other external factor. If this happens, execute the following procedure to reset the microcomputer and return the unit to its normal operating condition.

- Please note that resetting the microcomputer will clear the contents of the memory and return the unit to the state it was in when it left the factory.

For the U.S.A. and Canada

Unplug the power cord from the wall outlet, then plug it back in while holding down the POWER ON/STANDBY  key.

For other countries

With the power cord plugged in, turn the POWER ON/OFF key OFF. Then, while holding down the ON/STANDBY  key, press POWER ON/OFF key.

Amplifier

Symptom	Cause	Remedy
No sound from the speakers.	<ul style="list-style-type: none"> • The speaker cords are disconnected. • VOLUME is set to the minimum position. • MUTE is ON. • The SPEAKERS switches are set to OFF. 	<ul style="list-style-type: none"> • Connect them properly referring to "Connecting the speakers". → 13 • Adjust the volume to a proper level. • Turn OFF the MUTE. → 20 • Set the SPEAKERS switch to ON. → 18
The standby indicator blinks and sound is not output.	<ul style="list-style-type: none"> • Speaker cords are short-circuited. 	<ul style="list-style-type: none"> • Turn the power off, eliminate the short-circuiting, then turn on the power again.
Sound is not output from one of the speakers.	<ul style="list-style-type: none"> • The speaker cord is disconnected. 	<ul style="list-style-type: none"> • Connect it properly referring to "Connecting the speakers". → 13
Sound is not output from the surround speakers and / or the center speaker, or their sound is very soft.	<ul style="list-style-type: none"> • The surround speaker cords and/or the center speaker cord is disconnected. • A surround mode has not been activated. • The surround and/or center volume controls are set to the minimum level. 	<ul style="list-style-type: none"> • Connect it properly referring to "Connecting the speakers". → 13 • Select a surround mode. • Adjust the speaker levels using the test tone. → 17
When playing a Dolby Digital source signal using a DVD player, the sound is cut off soon after it starts.	<ul style="list-style-type: none"> • There are many possible causes for this problem, depending on the type of DVD player used. 	<ul style="list-style-type: none"> • Set the input mode to digital manual before starting playback of the Dolby Digital source. → 8
No sound is produced during playback from a DVD player.	<ul style="list-style-type: none"> • The input mode is set to digital manual. 	<ul style="list-style-type: none"> • Press the INPUT MODE key to select to full auto mode. → 8
A video source cannot be recorded normally.	<ul style="list-style-type: none"> • The software is copy-guarded. 	<ul style="list-style-type: none"> • Copy-guarded video software cannot be recorded.

Tuner

Symptom	Cause	Remedy
Radio stations cannot be received.	<ul style="list-style-type: none"> • No antenna is connected. • The broadcast band is not set properly. • The frequency of the desired station is not tuned. 	<ul style="list-style-type: none"> • Connect an antenna. → 14 • Set the broadcast band properly. • Tune the frequency of the desired station. → 21
Interference.	<ul style="list-style-type: none"> • Noise due to ignition of an automobile. • Noise due to interference from an electric appliance. • Noise due to a nearby TV set. 	<ul style="list-style-type: none"> • Install the outdoor antenna away from the road. • Turn off the power to the appliance. • Install the receiver farther away from the TV.
A station which was preset cannot be received by pressing the corresponding numeric key.	<ul style="list-style-type: none"> • The preset station belongs to a frequency that cannot be received. • The preset memory was cleared because the power cord had been unplugged for a long period of time. 	<ul style="list-style-type: none"> • Preset a station with a receivable frequency. • Preset the station again.

Remote control unit

Symptom	Cause	Remedy
Certain inputs cannot be selected using the remote control.	<ul style="list-style-type: none"> • No setup codes registered at the respective input(s). 	<ul style="list-style-type: none"> • Register a setup code at the respective input(s). → [28]
Remote control operation is not possible.	<ul style="list-style-type: none"> • The remote control is set to a different operation mode. • Batteries are exhausted. • The remote control unit is too far away from the main system, controlling angle is too large, or there is an obstacle between the receiver and the remote. • The audio cords and system control cords are not connected properly. • No tape or CD is placed in the source component. • An attempt is made to play a tape which is being recorded in the cassette deck. • The remote control has not been set to the operation mode for the component you wish to control. 	<ul style="list-style-type: none"> • Press the any of the Input Selector keys to select the appropriate operation mode. • Replace with new batteries. • Operate the remote control unit within the controllable range. • Connect properly referring to "Setting up the system". • Place the tape or CD in the source component which you want to play. • Wait for recording to complete. • Press any of the source keys or SRC Power key to activate the operation mode for the component you want to control before operation. → [29]

Specifications

 **Caution : Read this page carefully to ensure safe operation.**

For the U.S.A and Canada

AUDIO section

Rated power output during STEREO operation

100 watts per channel minimum RMS, both channels driven, at 8Ω from 40 Hz to 20 kHz with no more than 0.7% total harmonic distortion. (FTC)

Effective power output during SURROUND operation

FRONT (40 ~ 20 kHz, 0.7% T.H.D. at 8Ω one channel driven)	100 W + 100 W
CENTER (40 ~ 20 kHz, 0.7% T.H.D. at 8Ω one channel driven)	100 W
SURROUND (40 ~ 20 kHz, 0.7% T.H.D. at 8Ω one channel driven)	100 W + 100 W
SURROUND BACK (40 ~ 20 kHz, 0.7% T.H.D. at 8Ω one channel driven)	100 W
Total harmonic distortion	0.05% (1 kHz, 50 W, 8Ω)
Frequency response	CD/DVD 20 Hz ~ 70 kHz, +0 dB, -3.0 dB
Signal to noise ratio (IHF'66)	CD/DVD, AUX, TAPE, VIDEO 1, VIDEO 2 95 dB
Input sensitivity / impedance	CD/DVD 550 mV / 47 kΩ DVD/6CH INPUT 550 mV / 47 kΩ
Output level / impedance	TAPE REC 550 mV / 1 kΩ PRE OUT (SUBWOOFER) 1.5 V / 2.2 kΩ
Tone control	BASS ±10 dB (at 100 Hz) TREBLE ±10 dB (at 10 kHz)
Loudness control	VOLUME at -30dB level +8 dB (at 100 Hz)

For other countries

AUDIO section

Rated power output during STEREO operation

100 watts per channel minimum RMS, both channels driven, at 8Ω from 40 Hz to 20 kHz with no more than 0.7% total harmonic distortion. (FTC)

Effective power output during SURROUND operation

FRONT (1 kHz, 0.7% T.H.D. at 8Ω one channel driven)	100 W + 100 W
CENTER (1 kHz, 0.7% T.H.D. at 8Ω one channel driven)	100 W
SURROUND (1 kHz, 0.7% T.H.D. at 8Ω one channel driven)	100 W + 100 W
SURROUND BACK (1 kHz, 0.7% T.H.D. at 8Ω one channel driven)	100 W
Total harmonic distortion	0.05% (1 kHz, 50 W, 8Ω)
Frequency response	CD/DVD 20 Hz ~ 70 kHz, +0 dB, -3.0 dB
Signal to noise ratio (IHF'66)	CD/DVD, AUX, TAPE, VIDEO 1, VIDEO 2 95 dB
Input sensitivity / impedance	CD/DVD 550 mV / 47 kΩ DVD/6CH INPUT 550 mV / 47 kΩ
Output level / impedance	TAPE REC 550 mV / 1 kΩ PRE OUT (SUBWOOFER) 1.5 V / 2.2 kΩ
Tone control	BASS ±10 dB (at 100 Hz) TREBLE ±10 dB (at 10 kHz)
Loudness control	VOLUME at -30dB level +8 dB (at 100 Hz)

DIGITAL AUDIO section

Sampling frequency	32 kHz, 44.1 kHz, 48 kHz, 96 kHz
Input level / impedance / wave length	Optical (-15 dBm ~ -21 dBm), 660 nm ±30 nm Coaxial 0.5 Vp-p / 75 Ω

VIDEO section

VIDEO inputs / outputs	VIDEO (composite) 1 Vp-p / 75 Ω
S-VIDEO inputs/outputs	S-VIDEO (luminance signal) 1 Vp-p/75 Ω S-VIDEO (chrominance signal) 0.286 Vp-p/75 Ω

FM tuner section

Tuning frequency range	87.5 MHz ~ 108.0 MHz
Usable sensitivity (MONO)	VR-707 1.3 μV (75 Ω) / 13.2 dBf (75 kHz DEV., SINAD 30 dB) KRF-V6070D 1.6 μV (75 Ω) / 15.2 dBf (75 kHz DEV., SINAD 30 dB)
50dB quieting sensitivity	STEREO 28 μV (75 Ω) / 40.2 dBf
Total harmonic distortion (1 kHz)	MONO 0.5% (71.2 dBf input) STEREO 0.7% (71.2 dBf input)
Signal to noise ratio (1 kHz, 75 kHz DEV.)	MONO 75 dB (71.2 dBf input) STEREO 68 dB (71.2 dBf input)
Stereo separation (1 kHz)	40 dB
Selectivity (±400 kHz) VR-707	70 dB
KRF-V6070D	50 dB
Frequency response	(30 Hz ~ 15kHz), +0.5 dB, -3.0 dB

AM tuner section

Tuning frequency range	10 kHz step (VR-707) 530 kHz ~ 1,700 kHz 10 kHz step (KRF-V6070D) 530 kHz ~ 1,610 kHz 9 kHz step (KRF-V6070D) 531 kHz ~ 1,602 kHz
Usable sensitivity (30% mod., S/N 20dB) (VR-707)	16 μV / (600 μV/m)
Usable sensitivity (KRF-V6070D)	16 μV / (600 μV/m)
Signal to noise ratio (30% mod. 1 mV input)	50 dB

GENERAL

Power consumption VR-707	2.2 A
KRF-V6070D	280W
AC outlet	SWITCHED
VR-707	(total 150 W, 1.25 A max.)
KRF-V6070D	(total 90 W max.)
Dimensions	W : 440 mm (17-5/16") H : 143 mm (5-5/8") D : 303 mm (11-15/16")
Weight (Net)	VR-707 8.7 kg (19.18 lb) KRF-V6070D 9.3 kg (20.50 lb)

Notes

1. KENWOOD follows a policy of continuous advancements in development. For this reason specifications may be changed without notice.
2. The full performance may not be exhibited in an extremely cold location (under a water-freezing temperature).

KENWOOD

For your records

Record the serial number, found on the back of the unit, in the spaces designated on the warranty card, and in the space provided below. Refer to the model and serial numbers whenever you call upon your dealer for information or service on this product.

Model _____ Serial Number _____